



广东·莞深
GUANGDONG · GUANSHEN

PROCUREMENT GUIDE

外商采购指南



GUANSHEN INTELLIGENT MANUFACTURING TECHNOLOGY EQUIPMENT TRADING CENTER



General Profile



Guanshen Group is a professional industrial investment, management and operation enterprise. Since 2000, it has been involved in the hardware machinery mold industry, and so far has more than 20 years of professional market operation experience. It is a trusted professional service provider in the field of intelligent manufacturing supply chain



CATALOGS

001

Cutting Tools

064

Machine Tool Accessories

076

Metal working fluids

078

Carbide & Materials

089

Gauges and Measuring Instruments

094

Mold Accessories

099

Abrasives

101

Pneumatic Components



株洲硬质合金集团有限公司
ZHUSHOU CEMENTED CARBIDE GROUP CO., LTD.



SINCERITY CREATES VALUE

TECHNOLOGICAL INNOVATION

The company has the State Key Laboratory of Cermited Carbide, the State-recognized Enterprise Technology Center, State-recognized industrial product quality control and technology evaluation laboratory, China Nonferrous Metals Industry Cemented Carbide Quality Inspection Station, is a national technology innovation demonstration enterprise, National Intellectual Property Demonstration Enterprise, Postdoctoral Research Station in Hunan Province. The company has obtained the certification of quality, occupational health and safety, environmental management and intellectual property management system. The company has undertaken a number of national "863" and "973" programs, National Innovation Capacity Building Program, National Science and Technology Support Program and other major scientific and technological projects, as well as national strategic innovative products and key new products and national strategic innovative products and key new product projects. Some of the scientific research achievements have reached the international advanced level, and the company has won more than 120 honors and awards at the provincial and ministerial levels. In 2011, "Key Technology for Deep Development and Application of Difficult-to-metallize Tungsten Resources" was awarded the First Prize of National Scientific and Technological Progress. In 2015, "High-performance tungsten-based composite materials and their applications" won the second prize of National Technical Invention. In 2019, "High-Efficiency and High-Reliability Microfabrication Technology and Application for High-End Printed Circuit Boards" won the Second Prize of National Scientific and Technological Progress. The company owns more than 1,000 valid patents, including 440 invention patents. Our advantageous products such as cemented carbide profiles, ball teeth and rollers have been patented in foreign countries, and 15 PCT patents have been declared and 10 foreign patents have been authorized. It has obtained 10 foreign patent authorizations. In the past 10 years, we have compiled and revised 119 national standards and industry standards. The company supervises and organizes "Cemented Carbide", which is a professional academic journal with national public circulation. It is the core journal of Chinese science and technology, and was evaluated by China Association for Science and Technology in 2020 as the important and recognized journal for academia at home and abroad.



ADVANTAGES AND LEADING PRODUCTS



Cemented carbide rods and shaped cutting materials



Rolls and Large Products



Ball tooth drills and engineering tools



Mold Materials and Carbide Shaped Products

QUALITY ASSURANCE

The company always adheres to the quality policy of "emphasizing science and technology, strict management, quality first. Diamond brand products to meet customer needs" quality policy. Passed the quality, occupational health and safety and environmental management, intellectual property rights system certification. In 2022, we won the "Hunan Provincial Governor Quality Award" and in 2023, we won the "China Quality Award Nomination Award". The company has always adhered to the concept of "all for customer service", closely focusing on customer needs, and constantly increase the technical services, and strive to improve the market service security capabilities.



ENTERPRISE CULTURE

Business Philosophy: World Tools, Wealth Sharpener
Enterprise Spirit: Diamond Spirit | The pursuit of excellence, unlimited enterprising
Management Philosophy: Management is heart-centered

Enterprise vision: Sincerity creates value, innovation achieves the future
Shared values: integrity, professionalism, innovation and efficiency
Strategic goal: to become China's first, the world's first-class hard materials industry group



ZCC-CT 株洲钻石切削刀具股份有限公司

地址：中国湖南株洲市天元区黄河南路
 网址：<http://www.zccct.com>
 邮箱：zccct@zccct.com
 电话：0731-22882431 22889477 22889409 22881671
 22880853 28895827 22889408 22889408



微信号：zccctweixin



抖音号：936635182

OKE 欧科亿
STOCK CODE: 688308

LEADING COMPREHENSIVE SUPPLIER SYSTEM SERVICE PROVIDER OF CNC CUTTING TOOLS IN CHINA



OKE Precision Cutting Tools Co., Ltd.

- Headquarter Address: Chuangye Road, Small and Medium-sized Enterprise Venture Park, Yiling County, Zhuzhou City, Hunan Province
- Branch Office Address: No. 8, Chuangye 4th Road, Lusong District, Zhuzhou City, Hunan Province
- Tel: 0731-22673968 Fax: 0731-22673961
- Official Website.





HIGH PRECISION DIE MOLD END MILLS

CRAFTSMANSHIP EXCELLENCE

ADVANTAGES AND FEATURES

Ultra-fine micro-particle matrix material, nano-composite PVD coating technology, Streamlined grinding technology and edge treatment process to ensure the stability of the cutting edge of the tool. Ultra-high accuracy (R3um), to meet the requirements of high-precision mold mirror surface machining carved and crafted to quality casting brand.



ZHUZHOU HUARUI PRECISION CUTTING TOOLS CO., LTD

Address: No.68, Chuangye 2nd Road, Lusong District, Zhuzhou City,
Hunan Province, China.

Official website: www.huareal.com.cn

Customer Service Tel: 0731-28216690



Official WeChat
Public Number



Official website



Video



Tik Tok



DRILLING AND EXCAVATING PRODUCTS

- Alloys for Mining
- Oil field tooth wheel drilling teeth
- Superhard Material Composite Sheet Substrate
- Alloys for hard rock milling
- Alloys for engineering construction



CUTTING TOOLS

- Precision cutting inserts
- Gravity cutting inserts
- Milling inserts
- Turning inserts

TOOL MATERIALS

- Solid Carbide Rods
- Cemented carbide internally cooled bars
- Carbide sheet



肯特官方公众号

株洲肯特硬质合金股份有限公司
ZHUZHOU KINGTAL CEMENTED CARBIDE CO.,LTD.

地址:湖南省株洲市天元区金月路99号
网址:www.kingtal.com



SHIKANG CUTTING TOOLS



Professional Walking Machine Cutting Tools

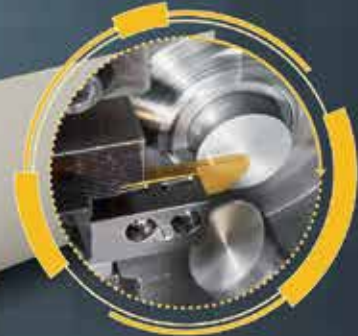

ISCAR is changing the world of cutting with intelligence!

CUTTING GROOVING



DONGGUAN SHIKANG HARDWARE & CUTTING TOOLS CO.

TEL: 0769-83003216/18819763343

E-MAIL: SK ISCAR@126.COM

Address: A20-21, Dongguan-Shenzhen Technical Equipment Manufacturing Trade City,
No.96 Zhen'an East Road, Xiaobian, Chang'an Town, Dongguan City, Guangdong Province, China.



Authorized Distributor
DONGGUAN GURUI HARDWARE MACHINERY CO.

Guanshen store: Changan Town, Dongguan City, Guangdong Province,
Dongguan Guanshen Intelligent Manufacturing Technology Equipment
Trading Center A building 22, 1 floor

SALES HOTLINE: 13717159901

**A GLOBAL LEADER IN TOOLING SOLUTIONS
AND A SPECIALIST IN HOLEMAKING.**



GUHRING 德国钻领刀具

High performance drill *GU500 PM* powder metallurgy high speed steel

No Centering, No Tool Lifting **Holemaking Tools**

Fixed shank design for more stable and easy clamping.

118 degree sharp angle with strong centering ability, no need to drill locating holes.

Wear-resistant coating - German Drill Leader's latest NANO-FIRE coating technology.



China General Agent

DONGGUAN KAMAS PRECISION TOOLS CO.

Guanshen Store: E29-30, Dong guan Guanshen Intelligent Manufacturing Technology Equipment Trading Center, xiaobian, Changan Town, Dongguan City, China
Tel: 13549410222 / 13580720843



Dongguan Zhuoran Precision Tools Co.

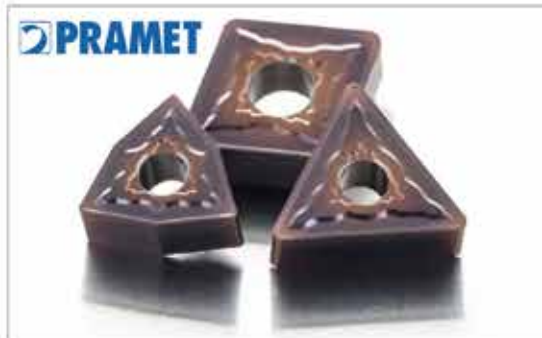
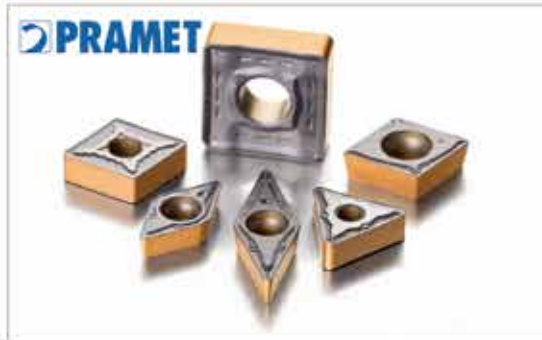

Main Products: German Drill Leader Drill Bits and Taps, British Dorma Drill Bits and Taps, Pramet Turning Inserts, Milling Blades, U Drill Inserts, ZR Tungsten Carbide Milling Cutter.



Tel: 189 2540 6555 135 5668 2886
 Address: No.51, Building B, Guanshen ZhiZhuang Trade City,
 Changan Town, Dongguan City, Guangdong Province, China



东莞市协亚精密机械有限公司

Dongguan Xieya Precision Machinery Co., Ltd

Our company focuses on research and development and sales of milling cutter inserts, turning cutter inserts, cutting blades, milling cutter rods, milling cutter discs, and can process metal materials such as steel parts, cast iron, stainless steel, high-temperature alloys, titanium alloys, and superhard materials.

We have a complete and scientific quality management system. We take an international perspective to serve advanced manufacturing, explore the high-end tool market, and provide customized product research and development, design, and service solutions for a wide range of tool customers.



TEL: 0769-81582298/13688999957

Http: www.xieyadj.com

Whatsapp: 17666197688





XINJIANFU HARDWARE TRADING (SHENZHEN) CO. XINJIANFU HARDWARE (GUANGDONG) CO.

Jianfu Hardware Trading Co., Ltd. was established in Hong Kong in 1990. For Taiwan, Hong Kong and mainland China to play a bridge role, to open the mold with the best products to domestic. After 33 years of innovation and practice, in line with the "reputation first, customer first, the real price" business purpose. With product excellence and quality service, has successfully built a professional wholesale European, American, Japanese and domestic high-quality cutting tools, CNC machining lubricants, tapping lubricants, lubricating oils and other lubricants. CNC machining lubricants, tapping oil, anti-rust oil and other series of products enterprises, with domestic special distribution rights.

JIANFU HARDWARE THE SIGN OF CONFIDENCE

for more than 30 years old, real goods, integrity to win the world!

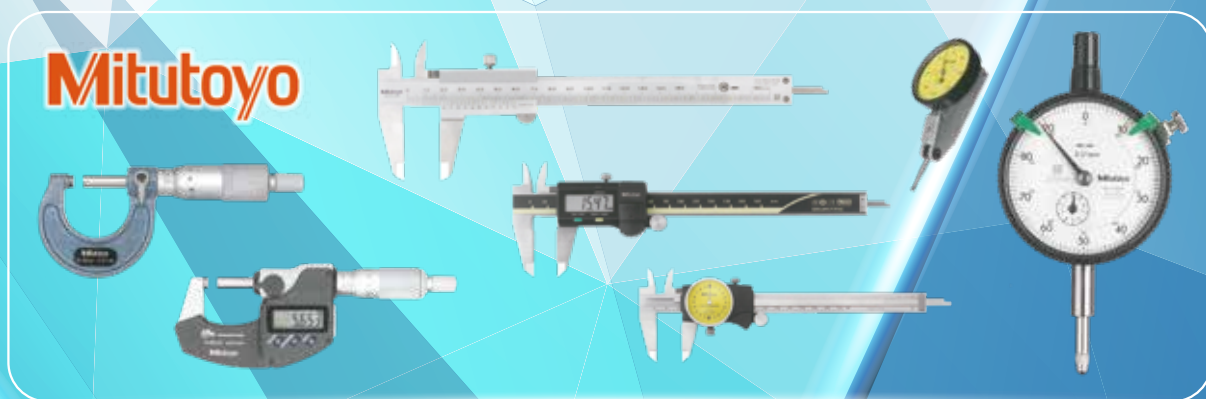

Our company represents the following brands



Dongguan: No.17-18, Building 1, Phase II, Dong guan Guanshen Intelligent Manufacturing Technology Equipment Trading Center, No.96, Zhen'an East Road, Chang'an.

TEL: 0769-85313137
QQ: 2853027250





VU Screw Tapping



Screw tapping for through holes



Dongguan Yingmanhe Hardware Machinery Co.

Tel: 189 2572 6688 Mr. Liang
 Address: No. A16-19, Dongguan-Shenzhen Smart Manufacturing Technology and Equipment Trade City,
 No. 96, Zhen'an East Road, Chang'an Town, Dongguan City, China.

Engman | 英门

德硕五金

DE SHUO HARDWARE

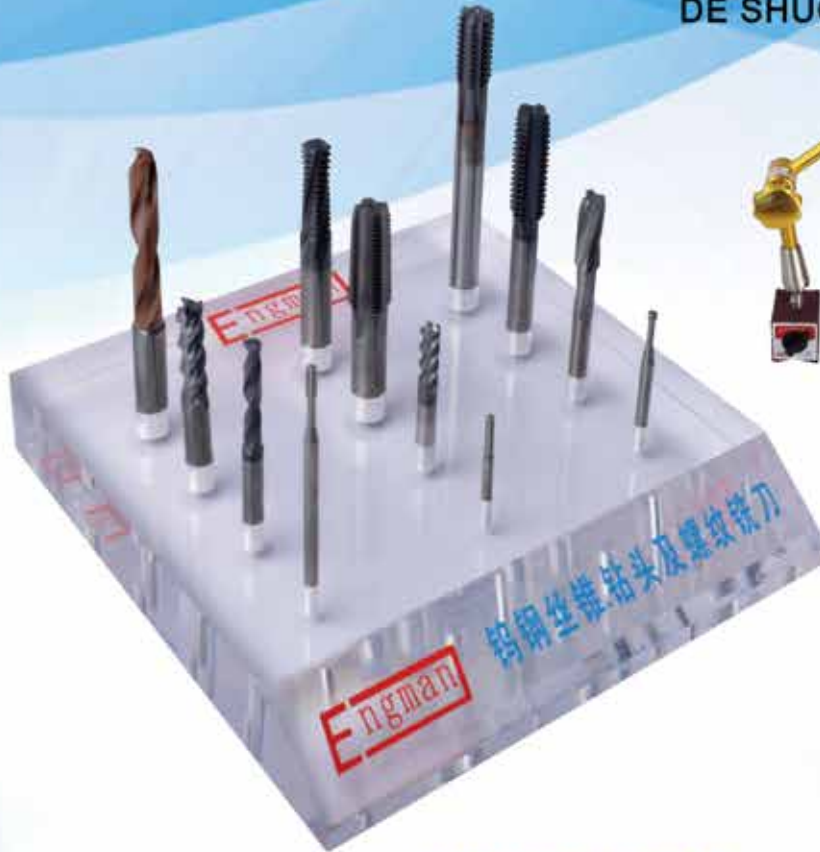

磁性表座系列
Magnetic Watch Holder Series

进口品牌丝锥部落
Imported brand tap tribe

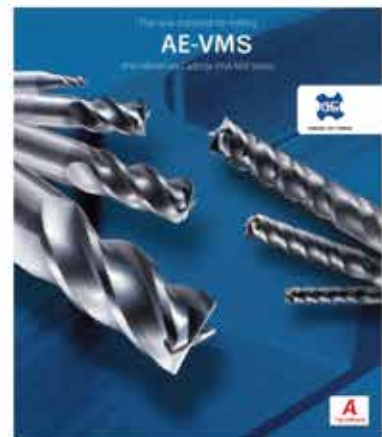
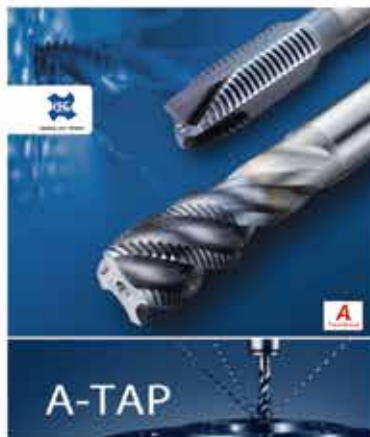
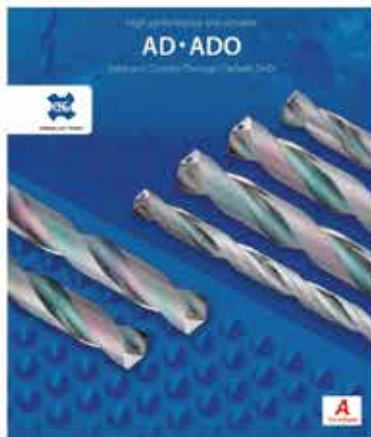

电话：0769-85396965



Taiwan Hui de tool Hardware Co., Ltd.
 Hongding (Dongguan)CuttingTool Co. Ltd.
 Guangdong Sheng Heng Ding Technology Co., Ltd.

Mould three treasures
 tungsten steel milling cutter
 tungsten steel back puller
 tungsten steel
 anti-vibration toolholder

Main Products

1. Plastic mold knife (Golden God Series)
2. Hardware Mold Knives (Blue Sky Door God Series)
3. Steel Alloy Cutter (for plastic mold)
4. Steel and Aluminum Alloy Date Cutter (Processing Aluminum Alloy)
5. Stainless steel high-efficiency wear-resistant roughing cutter
6. Aluminum alloy high-efficiency violent m rough milling cutter
7. Aluminum alloy high-gloss milling cutter
8. Alloy High-Efficiency Rough Milling Cutter



HIGH END PRECISION TOOL MANUFACTURING FACTORY



SINCERELY INVITE NATIONAL DEALERS



(Miss wang)



(Mr. wang)

B30-B31, Building B, No.96, Zhen'an East Road, Dong guan Guanshen Intelligent Manufacturing Technology Equipment Trading Center, Dongguan, China.
 TEL: 0769-85053993 81876166
 No.2, North Road, Hemei Township, Changhua, Taiwan (Head Office)
 TEL:886-4-7559458.7567158.



A12-13, Guanshen ZhiZhuang Trade City, No.96 Zhen'an East Road,
Chang'an Town, Dongguan City, Guangdong Province, China.

Tel: 13823764495 Ms. Ding

Taiwan Factory: No.10, Industrial 6th Road, An-Nan District, Tainan City
(Tainan Science and Technology Industrial Park)





鎌益有限公司
LiAMYi TOOL CO., LTD.

Connecting people · promoting social progress



捨棄式

切削刀具

**ABANDONED
 MILLING CUTTER**
 HIGH EFFICIENCY CUTTING

**TAIWAN KAMAKATSU SINCERELY
 INVITES NATIONAL AGENTS AND
 DISTRIBUTORS**

Dongguan Hengge Trading Co.



Contact ▶ Mr. Huang 13580923172

Flagship store in mainland China

03A, Building C, No. 96, Zhen'an East Road,
 Chang'an Town, Dongguan City, Guangdong Province,

Taiwan Factory

Taiwan Factory: No. 28, Lane 11, Lane 903, Section 4,
 Zhongqing Road, Daya District, Taichung City, Taiwan Province of China

Tel ▶ 0931430521

MULTI FUNCTIONAL HIGH EFFICIENCY TOOLS



134 3112 8777
Mrs mai

Taiwan cutting tools find Zhisheng a99 series,
classic permanent, worth cover up there!

Sincerely recruit national agents

Never had you so moved:

Excellent base material, superb technology

The classic a99!

Success comes from affordable prices and stable quality

And longer life spans;

To be the most cost-effective Taiwan cutter in the market...



GUANGDONG · GUANSHEN



SPECIALIZING IN TAIWAN DHF MILLING CUTTERS

WITH 16 TYPES OF HIGH EFFICIENCY AND PRECISION TUNGSTEN CARBIDE MILLING CUTTERS AND TUNGSTEN CARBIDE DRILLS.



不可分割可變螺距系列

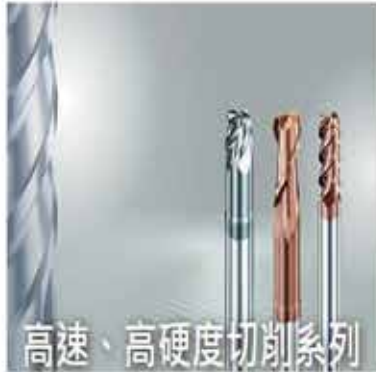

高速、高硬度切削系列
High speed and high hardness milling series



一般鋼材切系列
General Steel Series



鈦好切系列
Titanium easy Cut Series



破壞王-超級龍捲風系列
King of Broken Soil-Super Tornado Series

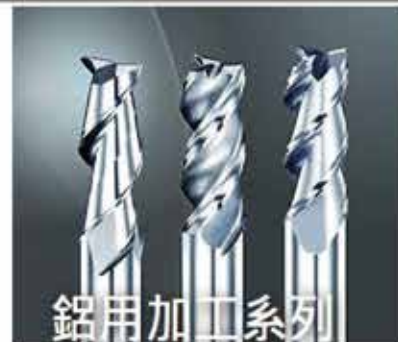

鋁用加工系列
Aluminum Processing Series



不鏽鋼切削系列
Stainless steel milling series



二代變形鎢鋼立銼刀
Second Generation Deformed Tungsten Steel End Mills

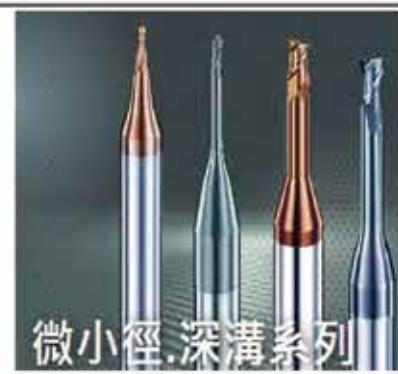

微小徑、深溝系列
Micro small diameter deep groove series



Customer Service

DONGGUAN SHUNHANG TECHNOLOGY CO.

Phone:15017069362 (WeChat same number)



Scan to shop



**Steel Processing Series
Turning Inserts**

CDBP TOOLS steel processing series turning inserts, using self-developed high toughness substrate, specially designed chipbreaker and new MTCVD coating, are particularly developed for medium and heavy roughing machining in wind power, mining, wheel and other industries. The core innovation is the special shape chipbreaker, which enables perfect chip forming and ultimately realize chip breaking within the desired range.

Milling Series Inserts

CDBP TOOLS milling series products, in outstanding insert geometry design, combined with excellent material, ensure safety and good cutting performance in machining; The products are good at face milling, plunge milling, slope milling, Spiral interpolation milling and profile milling etc., suitable for variety workpiece milling, widely used in most processing fields.



S1 Geometry

S2 Geometry

**Difficult-to-process
Series Inserts**

Ultra precise and cutting edge grinding technology ensures positioning accuracy and cutting edge quality. Suitable for high-precision machining of difficult-to-process materials.



Solid Carbide Milling Series

The unequal spiral geometry design and unequal tooth pitch, reduce the milling tools vibration when machining and effectively improve the tool life and workpiece surface finish.

Bangpu Cutting Tools(Guangdong)Co. Ltd.

Tel: 133 5085 9182 (Mr. Wu) E-mail: liuwu@bpcarbide.com

Address: Building G-258 in GuanShen intelligent manufacturing technology and equipment industry city

No. 96 Zhen'an middle road, Chang'an Town, Dongguan, Guangdong Province

Factory Address: No.998 Baicao Road, Western District of Hi-tech Zone, Chengdu, Sichuan Province

HJ Tools

Professional carbide product manufacturer for cutting tools



Carbide end mill

There are a total of 12 series of carbide end mills for ordinary steel processing, high-hard steel processing, graphite processing, stainless steel general processing, aluminum alloy general processing, and alloy processing.



Indexable inserts

Stainless steel inserts, steel turning inserts, cast iron inserts, drilling inserts, thread turning inserts, and milling inserts have complete specifications covering a variety of workpiece materials.

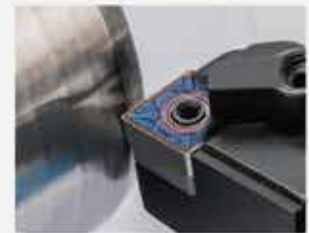

Carbide Drill Bits tools

GTD series general machining twist drill
High-performance substrate, advanced coating and post-processing technology, mature edge processing technology, new groove design.

Xiamen HJ Carbide Technology CO.,Ltd.

Whatsapp Account:+86 13696916596
Web : <https://xmcarbide.en.alibaba.com/>

E-M : jason@egretool.com
TEL : +86 13696916596
+86 13178886998



子和数控刀具有限公司 ZIHE CNC TOOL CO., LTD

Address: A32, Dongguan Changan Guanshen
Intelligent Manufacturing Technology Equipment
Trading Center, Dongguan, China
Tel: 13509209307 (Ms. Liu)

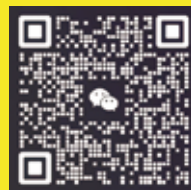

HAS BEEN COMMITTED TO THE RESEARCH AND DEVELOPMENT, MANUFACTURING, SALES,
TECHNICAL SERVICES AND IMPORT AND EXPORT BUSINESS OF METAL CUTTING TOOLS, METAL PRODUCTS





solve **difficult-to-machine** material problems



Professional processing grades below HRC 58°, mold steel, hardened material, nickel-based alloy.



Full- Ground Thread Insert

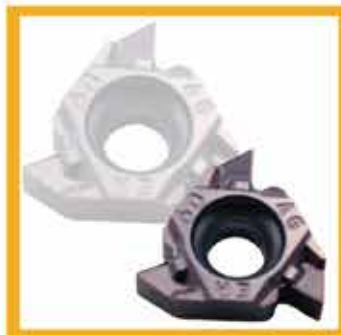

Sintered Thread Insert



Disc-shaped Oil and Casing Thread Insert



Deep Hole Thread Milling Inserts

Pitch range: 1.5-8.0

Inserts are processed by full grinding technology.

Strong overall hardness, sharp edge

Shock and wear resistance, not easy to chipping, smooth chip breakage

Provide efficient cutting, save machining time and improve machining efficiency;

Strong versatility, wide range of applications.

Mobile: +86-138099624058

Email: yz@yuzuan.cn.com

Factory: Building 1, No. 316, First Industrial Zone, Qiaotou Houjie, Dongguan Guangdong, China;

Boyue Flagship Store: A05-1-2, Boyue Hardware City, No. 60 Zhen'an Middle Road, Wusha, Chang'an, Dongguan City Guangdong, China;

Guanshen Flagship Store: 28 First floor, Building D, GuanShen Technology and Equipment Trading Zone, East Zhen'an Road, Xiaobian community, Chang'an Dongguan, Guangdong, China



Product Catalogue



Technical Support



INNSERTOOL

中科强锐



INNSERTOOL (Dongguan) CNC Cutting Tools Co.

Address: No.222-223/229-230, Building A, Guanshen Intelligent Technology & Equipment Industrial City, Chang'an Town, Dongguan City, Guangdong Province, China

Contact: Xu Wenxue 18781181199





CY CARBIDE MFG.CO.LTD., established in 2003, is a professional manufacturer and exporter of cemented carbide and cermet materials. CYC set up the brand "CYCT" for inserts R&D, and manufacturing. Our stable, effective and precision inserts are widely used for machining P, M, K, S, N and H work piece. Specially designed grades and types are suitable for turning, milling and drilling. Products are extensively applied in the industry of molds, automotive accessories, general machine, clean energy, 3C, aerospace, shipping, railway transportation, and heavy equipment etc.

Precision Inserts

> Turning inserts for cast Iron



> Turning inserts for Steel

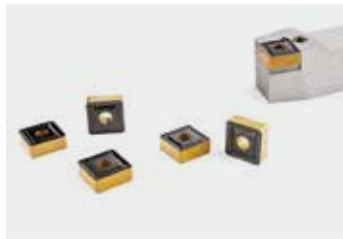

> Turning inserts for Stainless steel



> Cemented Carbide Milling Inserts



> Cermet Inserts



> Parting & Grooving / Drilling Inserts



CY CARBIDE MFG. CO., LTD.

Dongguan Tiz Hardware Machinery Co., Ltd.

Add. 03B, Building B, Wanshen Trade City, Dongguan, Guangdong, China.

Tel. 13631103545

www.cycarbide.com



用心做好每一把刀

深耕刀具行业二十余载
致力于“让制造更简单”



湖南邵阳总部·行业首家智能化刀具工厂



顶层研发中心·千万级瑞士普拉进口设备



公司实力·300余台全自动化高精度数控机床

湖南富兰地工具股份有限公司

地址: 湖南省邵阳市双清区魏城路和广福路交汇处 F-114
 电话: 13925820430
 邮箱: fullanti@fdtool.com
 网址: www.fdtool.com

Hunan Fullanti Tools Limited Company

A.D.D.: Hunan Province Shaoyang City Hunan Fullanti Tools Co., Ltd. Industrial Park plot F-114
 T.E.L.: 13925820430
 Email: fullanti@fdtool.com
 HTTP: www.fdtool.com





杜玛（常州）刀具有限公司
Duma(Changzhou) Tool Co.,Ltd



Factory Address: No.1 Cache Road, Xuejia Town, Xinbei District, Changzhou City, Jiangsu Province, China
 Dongguan Store: A231, Dong guan Guanshen Intelligent Manufacturing Technology Equipment Trading Center, No. 96, Zhen'an East Road, Chang'an Town, China
 Tel:13625850352



東莞市阿爾法精密工具有限公司
Dongguan Alpha Precision Tools Co., Ltd.



**Focusing on the research end milling cutter
for 3C ,aerospace, the car industry and mould
processing industry**

■ **高精密 | 高速度 | 高效率** ■

High Precision、 High speed、 High efficiency

TEL: 13859559991





DC426 XL 系列

DC426XL King Carbide Extra Long Edge Coated Drill Bits

20-60TIMES DIAMETER

Range of cutting edge diameter
0.30-3.00mm



For product details, please contact.
☎ 139-2925-4515 Su Manager

Dongguan City - Changan Guan-Shen Smart Manufacturing
Technology and Equipment Trade City, Building 4, 201-205

Designed / for / deep / hole / machining

60mm

φ1.0mm



Solid Carbide Milling Cutter Series



HUIYU CHANG CNC CUTTING TOOL CO., LTD.

Manager Yuan 0769-81076889

C23A-C26, Guanshen Trade City, No.96 Zhen'an East Road, Xuebian,
Chang'an Town, Dongguan, China





QUALITY RAW MATERIALS CRAFTED WITH CARE

The use of steel parts stainless steel castings universal quality carbide raw materials high toughness and high wear resistance and high temperature resistance to improve, to adapt to different working conditions.



SPECIALIZED IN MILLING

**RECRUITMENT OF AGENTS
AND DISTRIBUTORS**

Address: Room G251, Guanshen Trade City, No.96, Zhen'an East Road, Chang'an Town, Dongguan City, China.

Tel: 18561110456 Mr. Duan

ZHENJIANG ZHUZHUDRILL CARBIDE CO.



东莞市奥斯精威数控科技有限公司

DONGGUAN AOSIJINGWEI CNC TECHNOLOGY CO., LTD.

公司简介

东莞市奥斯精威数控科技有限公司 (Dongguan AOSIJINGWEI CNC Technology Co., Ltd.) 是一家集生产、加工与销售数控刀具为一体的产销型企业。主营产品系列：标准钨钢铣刀批发（铣刀类别详见下图），并可根据客户的个性化需求定制产品。

奥斯精威的产品优势主要表现在以下三方面：

优势一：自主产能及出厂品质保证。

优势二：进口涂层核心技术支撑。

优势三：无可比拟的产品创新能力。不断进行技术创新，以保证刀具使用和加工服务品质。



Dongguan AOSIJINGWEI CNC Technology Co., Ltd. is a manufacturer and marketer of CNC tools in Dongguan. Main product series: Standard Tungsten Steel Milling Cutter Wholesale (milling cutter type see below), and can be customized according to customer demand. The product advantages of osquist are mainly manifested in the following three aspects: Advantage One: independent production capacity and factory quality assurance. Advantage Two: import core technical support coating. Advantage Three: incomparable product innovation ability. Continuous technical innovation to ensure the use of cutting tools and processing service quality.

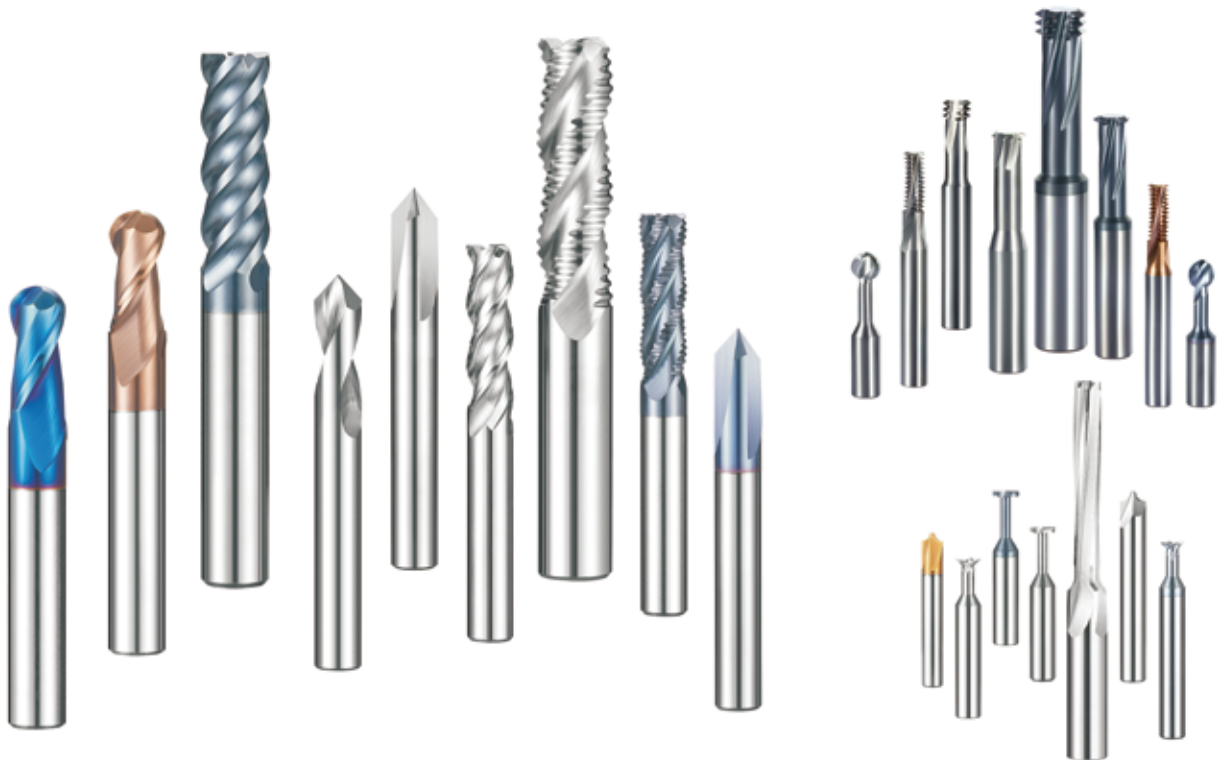

地址：广东省东莞市长安镇振安东路96号莞深商贸城一楼F13A-F13B
 ADDRESS: F13A-F13B, 1/F, GUAN SHEN COMMERCIAL CITY, NO. 96
 ZHEN AN EAST ROAD, CHANG 'AN TOWN, DONGGUAN CITY,
 GUANGDONG PROVINCE
 CONTACT : MISS AMIN ZHANG
 TEL: 13760306869/13829282855

常州市霸原数控工具有限公司
 Changzhou Ba yuan CNC Tools Co.

非标铣刀 · 来图定制
 Non-standard milling -Customized

工厂地址:常州市新北区西夏墅镇南河沿71号
 Factory Address:No.71,Nanheyuan,Xixiashu Town,
 Xinbei District,Changzhou City,Jiangsu Province,China.

联系方式:13510236795(微信同号)
 Contact:13510236795(WeChat)

东莞分部:广东省东莞市长安镇莞深智造技术装备工业城G18
 Dongguan Branch:Dongguan City, Guangdong Province, Guanshen Intelligent
 Manufacturing Technology Equipment Trading Center G18

联系方式:15814090504 15013643971(微信同号)
 Contact:15814090504 (WeChat same number)

坚固实用 | 不易断刀 | 切削锋利
 Non standard customization





东莞市柏荣科技有限公司
Dongguan Bai rong Technology Co., LTD.

- All kinds of MCD natural diamond cutting tools
- All kinds of PCD CBN diamond tools
- All kinds of carbide cutting tools, welding tools
- All kinds of extrusion taps/cutting taps
- Various types of cutter, BT / HSK shanks, collets
- All kinds of knife grain shank saw blade
- OSST Series for Stainless Steel
- ALL High efficiency series for aluminum
- OHHT65° high hardness series
- OUEG high temperature alloy series

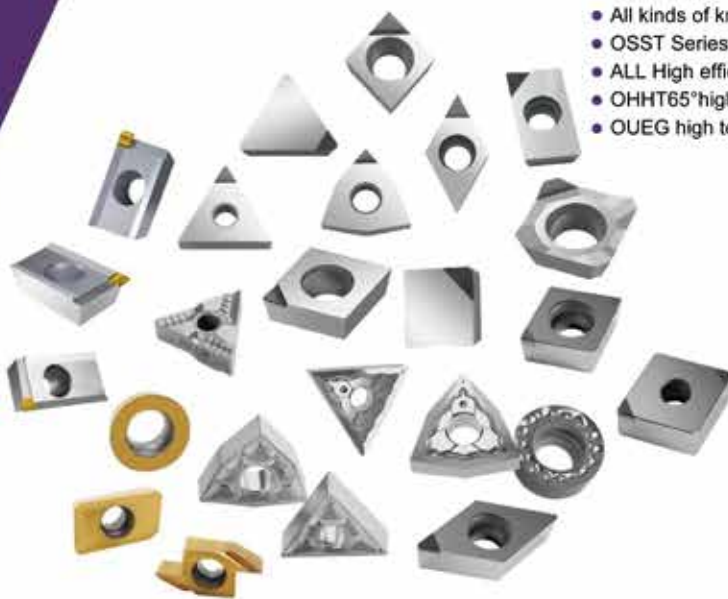

Store Address: 239, Building 3, No. 96, Zhen'an East Road, Chang'an, Dongguan City
E-mail: 356084099@qq.com
Tel: 18824256855 Zhang Xuejiao

BAOLIFENG DRILL BITS

CONTINUOUS EFFORTS TO MEET CUSTOMER NEEDS

SPECIALIZED IN TECHNICAL SERVICES FOR HOLEMAKING TOOLS

GXD General Purpose Drill

3-20MM 3D/5D 山东首家 现货供应



高端品质
可替换进口



- Suitable for high efficiency machining of ISO P,K, M materials.
- Can be customized according to customer requirements.

PXD series drills

3-20MM 3D/5D 山东首家 现货供应



NEW



- Scope of application: Economical and efficient machining of ISO P, K, M superb materials
- Can be customized according to customer requirements.

GSD hard-to-machine series drills

New materials, innovative chipformer design and multi-layer PVD coating. It is a specialized high-performance solution for the drilling of ISO M and S materials.



NEW



- Standard diameter range 3-16MM internal cooling design, drilling depth of 3D/5D/8D drill diameter Can be customized according to customer requirements.
- Can be customized according to customer requirements.

NON-STANDARD CUSTOMIZED SERIES DRILLS

- Total solution for hole processing
- Solve processing problems for customers
- Enhance customer competitiveness
- Continuous improvement to meet customer needs



Technical service support:13356395975

Factory Address:No.36, Maoshan Road, Huangdao District, Qingdao City, Shandong Province
South China Address:Room 205, Building A, Guanshen Intelligent Manufacturing Technology Equipment Trading Center, No.96 Zhen'an East Road, Chang'an Town, Dongguan City, Guangdong Province, China.



(扫一扫了解更多)



(公众号)



东莞北极光硬质合金有限公司 Dongguan Wandecut Carbide Co., Ltd.



Dongguan Wandecut Carbide Co.,Ltd. focuses on the research of cemented carbide tools Production and sales.

The sales department is located in the world famous mold manufacturing town, DongguanChangan, China. Company owner Battalion: Carbide Endmill, Inserts. Drill bits and otherproducts. Our products are in precision Parts, automobiles, mold manufacturing, militarymedical, 3C and other fields are widely used Universal application. Committed to providingour customers with the most cost-effective cutting tools And the best cutting schemeSince the establishment of the company has been adhering to the "realistic creation New,the pursuit of better "spirit of enterprise and" unity, forging ahead, truth, pragmatic " Enterprise style, and in Europe, the United States, the Middle East, Southeast Asia and other morethan 30 countries and regionsThere is a deep cooperation. In the future , the company willadd more business in six global sectors Yes. Based on the new era, practice the new mission.and strive to be a new era enterprise.



www.wandecut.com

Address: Guanshen Intelligent Manufacturing Technology Equipment Trading Center, a phase of Building E, No. 101

Tel: 18046922388 Mr. Chen



东莞市倍展精密工具有限公司

DONGGUAN BEIZHANG PRECISION TOOLS CO., LTD.

专业从事数控刀柄，镗刀，刀杆，刀盘。接受非标孔内加工刀具。
SPECIALIZING IN NC TOOL HANDLE, BORING TOOL, ARBOR, CUTTER HEAD. ACCEPT NON-STANDARD HOLE MACHINING TOOLS.



地址：广东省东莞市长安镇振安东路96号莞深商贸城F栋08号
ADD: NO. 08, BUILDING F, DONGGUAN SHENZHEN COMMERCIAL CITY, NO. 96 ZHENAN EAST ROAD, CHANG 'AN TOWN, DONGGUAN CITY, GUANGDONG PROVINCE
电话：18782899839
TEL: 18782899839





东莞市博欧硬质合金有限公司

DONGGUAN BOOUDP CEMENTED CARBIDE CO., LTD.

Dongguan Boou Cemented Carbide Co., Ltd. is a private enterprise integrating R & D, production and sales of cemented carbide products. The factory is located in Zhuzhou, Hunan, China's industrial tool production base, and Dongguan, Guangdong, the world's high-end manufacturing city. We specialized in manufacturing and selling of precision metal cutting tools and inserts for CNC machine. Such as turning tools, drilling tools, milling tools, boring tools, reaming tools. All products are high cost performance.



Professional supplier of total solutions for milling tools



📍 Add: B18, Building B, Guanshen Zhizao Technology and Equipment Industry City, Zhen 'an East Road, Chang 'an Town, Dongguan City, Guangdong Province, China

☎ Tel: +86-769-82289185

✉ E-mail: 565574382@qq.com

☎ Fax: +86-769-82289265

🗣 Whatsapp: +86 137 1185 0177





High Precision Hydraulic Toolholders

**TECHNOLOGY CREATES THE FUTURE,
QUALITY CHANGES THE WORLD**



High precision CNC series toolholder



High Precision Heat Shrinkable Toolholder

DONGGUAN CHONGDE PRECISION MACHINERY CO.



Contact: Lu Guangwen
Phone (with WeChat): 18928261446
Address: A28, Guanshen Trade City,
Zhen'an East Road, Chang'an Town, Dongguan

常州市创锦工具有限公司

CHANGZHOU CHUANGJIN TOOLS CO.,LTD.

CHUANGJIN



联系人：蒋先生
13626244778

为什么选择我们 WHY CHOOSE US

1
规模大
品质稳
Large scale
stable quality

拥有80台进口及国产加工中心、20台检测设备、3台涂层中心，是国内硬质标准刀具一线的科研、生产基地。流程化生产管理，选材、生产、检验、涂层严格的按工艺标准执行，使我们的品质稳定性始终如一。拥有五家直营门店仓储，布局前沿仓，强大的库存更好的为客户提供时效上的便捷。

With 80 imported and domestic machining centers, 20 testing equipment, and 3 coating centers, it is a research and production base for hard standard cutting tools in China. Process oriented production management, with strict adherence to process standards for material selection, production, inspection, and coating, ensures consistent quality stability. We have five direct store warehouses, layout cutting-edge warehouses, and strong inventory to better provide customers with timely convenience.

2

性价比高
Cost-effective

我们从材料代理、生产、涂层、销售拥有完整的产业链，与国内一线材料生产商成为了战略合作伙伴，磨削、涂层全自主的成本控制能力奠定了我们性价比优势，为客户创造更多的盈利空间。

We have a complete industrial chain from material agency, production, coating, and sales, and have become strategic partners with domestic frontline material manufacturers. Our cost control capabilities for grinding and coating have laid the foundation for our cost-effectiveness advantage, creating more profit space for customers.

3

定制化服务
Customized services

我们有丰富的标准刀具行业应用及被加工材料经验，根据客户的加工要求，从选材，工艺设计，涂层更有针对性的方案设计，我们拥有成熟的生产流程及工艺标准，为交期及品质保证，标准刀具的成本控制优势为客户提供定制化刀具的价格优势。

We have rich experience in the application of standard cutting tools in the industry and the materials to be processed. Based on customer processing requirements, we have a more targeted solution design from material selection, process design, and coating. We have mature production processes and process standards to ensure delivery time and quality. The cost control advantage of standard cutting tools provides customers with a price advantage of customized cutting tools.

4

电商服务
意识强
Strong awareness
of e-commerce
services

我们多年来配合了众多电商零售和外贸TO-B、TO-C端客户的经验，清楚的知道市场的需求，不断的开发市场需求的新品，让我们客户去开拓新的领域和利润点，提供了让客户不断成长和脱颖而出的机会，我们做坚强的后盾，你们做擅长的运营。

We have cooperated with many e-commerce retail and foreign trade TO-B and TO-C clients for many years, and have a clear understanding of market demand. We constantly develop new products that meet market demand, allowing our clients to explore new fields and profit points, providing opportunities for them to continuously grow and stand out. We are a strong supporter, and you are skilled in operation.

5

规格齐研发强
Uniform specifications
and strong research
and development
capabilities

针对行业刀具及被加工材料每半年推出客户所需求的新品，不断的完善市场空白规格，所有新品从立项、研发、试制、测试经过严谨的态度，与国内刀具上市公司及进口品牌互相合作，目前硬质合金标准刀具的SKU规格备货高达1万余种。更好的为客户提供一站式采购的便捷。

We launch new products every six months that meet the needs of customers for cutting tools and processed materials in the industry, continuously improving the blank specifications in the market. All new products undergo rigorous attitude from project approval, research and development, trial production, and testing, and cooperate with domestic tool listed companies and imported brands. Currently, there are over 10000 SKU specifications for hard alloy standard cutting tools in stock. Better provide customers with one-stop procurement convenience.



 达海数控机械有限公司
DAHAI CNC MACHINERY LIMITED

DaElement

Dahai CNC Machinery LIMITED was founded in 1996.
It is a carbide CNC tool enterprise integrating R&D, design, sales, and training.



The products are widely used in military industry, ships, medical devices, human implants, aerospace, mold industry, machinery industry, high-tech research and development, high-end communication electronics, precision processing and other industries.



TEL: +86-769 87882889/+86-595 22590877
EMAIL: dahaimj@vip.163.com
ADDRESS: Room 221-222, Building C, Guanshen Zhizao Equipment Technology Industrial City, Chang'an Town, Dongguan City, Guangdong Province
www.dahaidj.com

走芯机车床用刀具源头工厂 Automatic lath cutting tools manufacturer



旋风铣刀盘/刀片
Whirling cutter and inserts

成型刀片
profiling inserts

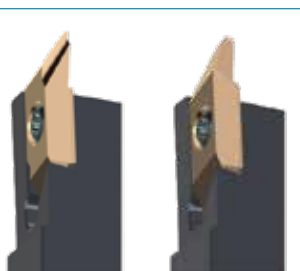
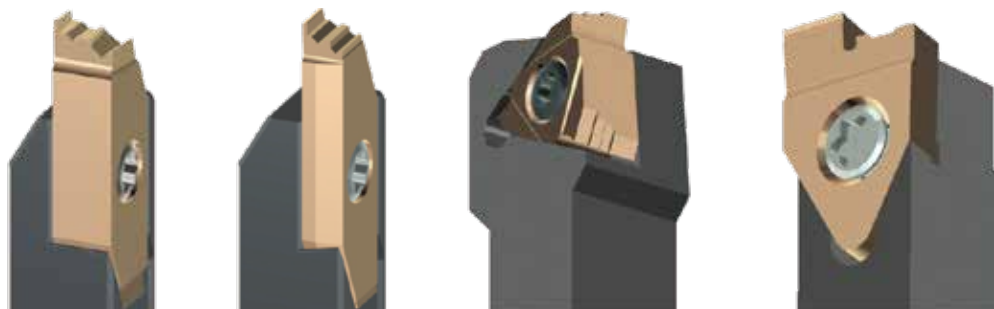

后扫
Back Turning

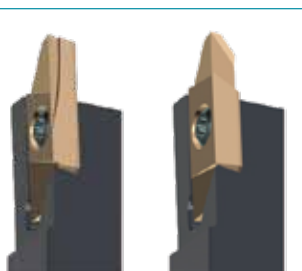

前扫
Front Turning

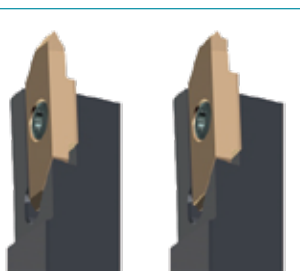

螺纹
Threading

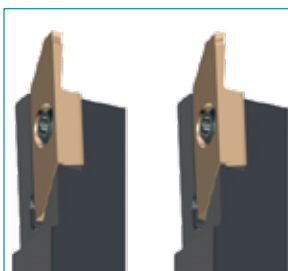

切断/切槽
Cut-off/Grooving

德和美

VIRTUE. HARMONIOUS. BEAUTY

深圳市德和美科技有限公司
东莞市长安镇振安东路96号莞深智造工业城B12
联系人:黄先生 13902487997
www.vhbttools.com

DEZHOU JIARUI PRECISION MACHINERY CO.

Good tools come from CARAY
好刀盘 · 佳瑞造 · 质量可靠



Song Chunli

Tel: +86 18805341000

Address: No. D08, Dong guan Guanshen Intelligent Manufacturing Technology
Equipment Trading Center, No.96, Zhen'an East Road, Chang'an Town, Dongguan

北京·大兴

德州

平原东
德州佳瑞





TUNGSTEN STEEL CUTTING TOOL MANUFACTURER!

AX SERIES-COPPER ELECTRODE SPECIALIZED CUTTER

Suitable for precision copper electrodes, terminals, connectors and CNC gold and silver jewelry processing, with the advantages of good cleanliness, accurate size tolerance and other advantages.

Applied to brass, purple copper, red copper, aviation aluminum Pure gold, silver, etc.

AG SERIES - MILLING CUTTERS FOR MOLDS

Suitable for HRC52 or less mold steel processing such as NAK80, SKD11, P20, S136H, etc. plastic, hardware mold, automotive, medical, automation parts field.

A new generation of AG nano-coating is used to enhance wear resistance and improve long-lasting processing stability.

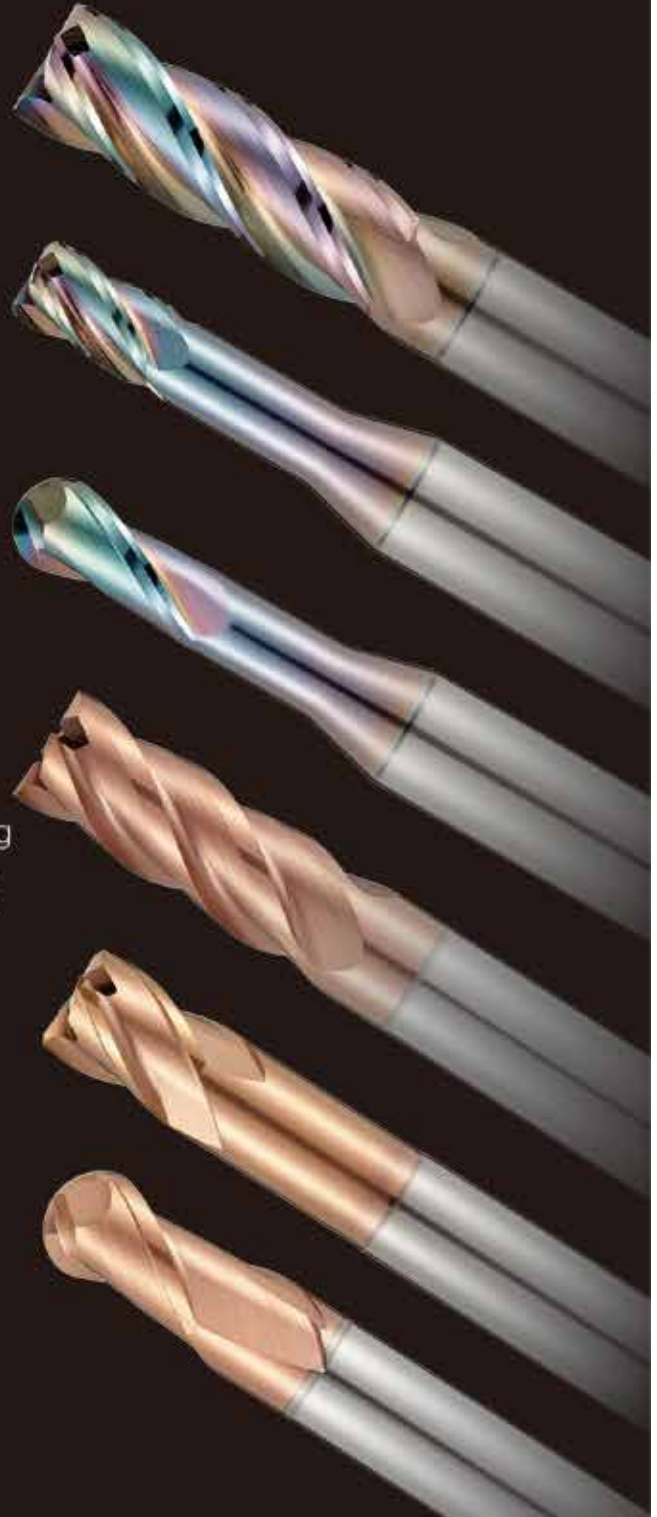

DONGGUAN KEZE INTELLIGENT EQUIPMENT CO.

Address: Room 218, Building H, Dong guan Guanshen Intelligent Manufacturing Technology Equipment Trading Center, No. 96, Zhen'an East Road, Xiaobian, Chang'an Town, Dongguan
Tel: 13925709590/13416787663



SMALL BORING TOOL



DONGGUAN DOERLI CNC CUTTING TOOLS CO.
 CHUANG XIN HAI TUNGSTEN CARBIDE CUTTING TOOLS
 WHOLESALE HEADQUARTERS

DUO ER LI SMALL BORING TOOLS
YOUR SMART FIRST CHOICE!

(Generally used for core walkers, CNC lathes)

请扫二维码咨询报价!



广东省东莞市长安镇霄边莞深五金刀具城C11-12
 电话: 0769-85097685
 手机: 13751344819
 QQ: 1010731757

广东省东莞市长安镇商贸模具超市C005
 电话: 0769-85847130
 传真: 0769-85471588
 QQ: 472833629



MANUFACTURERS DIRECT SALES PRICE GREAT BENEFITS

快速切换简单快捷
轻松铣削

工厂直销

BAP300R/400R
直角铣刀杆

工厂直销

- 耐磨耐用
- 抗震防抖
- 铣削精准

高温淬火 持久耐用

优选42CrMnTi材质
保障加工稳定

工厂直销

42CrMnTi材质

EMR/EMRW/TRS
圆鼻铣刀盘

工厂直销

- 耐磨耐用
- 抗震防抖
- 仿形优化

高效防震 规格齐全

紧固设计
高精度

工厂直销

锋利切削刃
可减小切削压力

工厂直销

数控铣刀片
规格齐全

工厂直销

- 优质原材
- 耐磨性好

抗崩耐磨 刀口锋利

锋利耐磨
一片抵多片

工厂直销

For more information, please contact customer service

DONGGUAN FENGJIE PRECISION TOOLS CO.

Address: No.D 13-15, Dongguan City, GuanShen ZhiZhuang Hardware City
Tel: 15362414146 (WeChat synchronization)

FM 锋芒刀具
 fēngmáng Feng Mang Cutting Tools

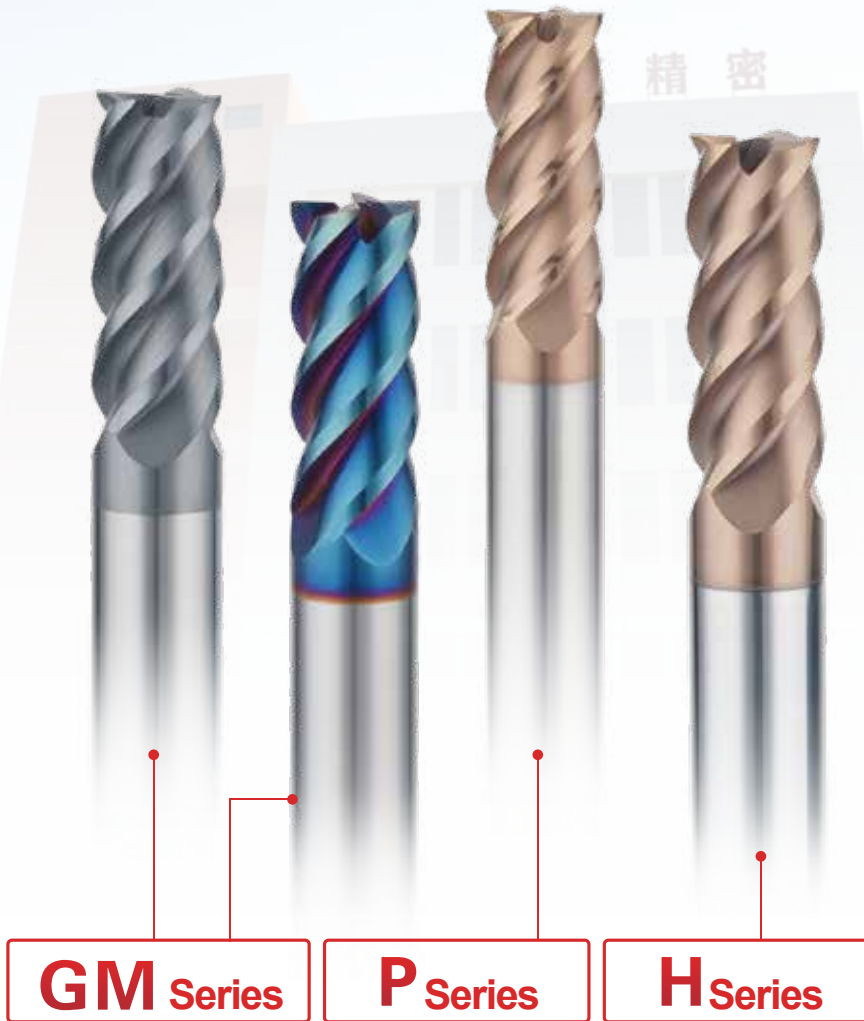

HIGH HARDNESS, HIGH TOUGHNESS, SPECIAL DESIGN

GANZHOU KAIJU PRECISION TOOLS CO.

Chang'an Store: **180 7979 9418**

Ganzhou Factory: **153 7778 2287**

Address: A255, 2/F, Building A, Dong guan Guanshen Intelligent Manufacturing Technology Equipment Trading Center

**NATIONAL
INVESTMENT
TO JOIN**

HNW[®] 汉诺威切削工具

金属切削专家 服务世界机床

HANOVER CUTTING TOOLS

Tik Tok/WeChat the same number : sky180 TEL:138 2368 3348

**Craftsmen make cutting tools,
craftsmen make cutting tools,
with a sharp edge and sincerity.**

**STANDARD MILLING CUTTERS IN STOCK,
RECRUITING AGENTS NATIONWIDE**



运营中心: 东莞市长安镇霄边莞深智造技术装备工业城A206

OPERATION CENTER: XIAOBIAN DONGGUAN SHENZHI MANUFACTURING TECHNOLOGY AND EQUIPMENT INDUSTRIAL CITY A206, CHANG'AN TOWN, DONGGUAN CITY



WeChat QR Code



Tik Tok QR Code

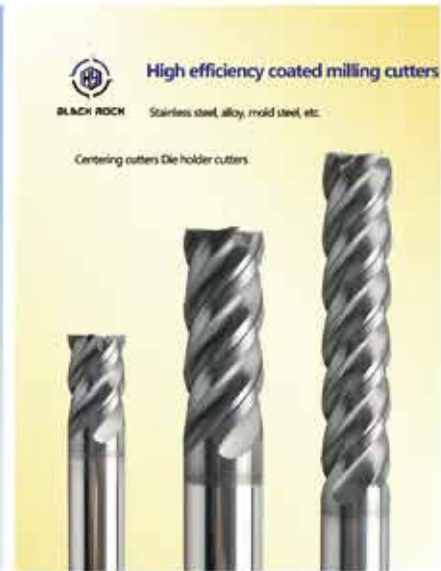
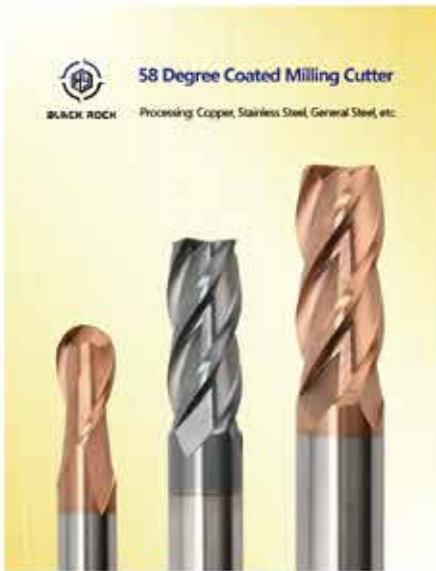
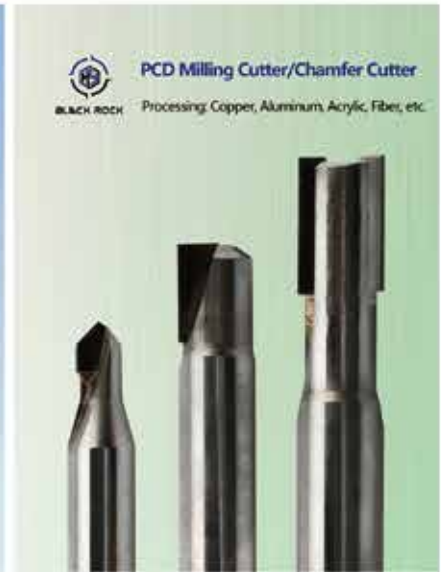
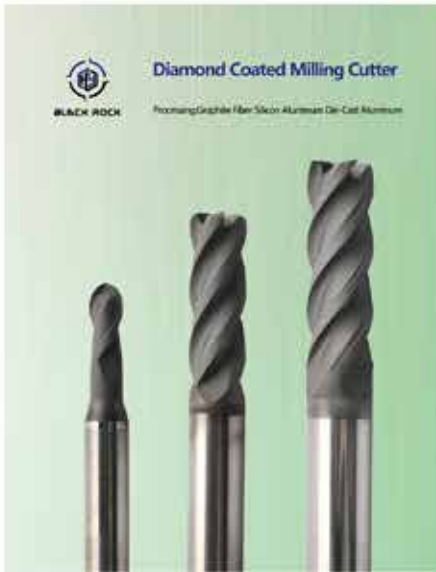

DONGGUAN BLACK ROCK CUTTING TOOL TECHNOLOGY CO.

**TUNGSTEN CARBIDE MILLING CUTTER DIAMOND COATED GRAPHITE MILLING CUTTER
PCD MILLING CUTTER SHANK DRILL SHANK AND OTHER MACHINE TOOL ACCESSORIES**



SCAN TO ADD FRIENDS

TEL: 137 1188 3486 MR. ZENG

22-23, Building B, Guanshen Intelligent Manufacturing Technology Equipment Trading Center, No.96, Zhen'an East Road, Chang'an Town, Dongguan City, Guangdong Province, China.



东莞市江龙精密刀具科技有限公司

Dongguan Jianglong Precision Tool Technology Co., LTD

Dongguan Jianglong Precision Tool Technology Co., LTD., is a set of production and sales of high precision cutting tools and services as one of the tool wholesale company, located in Dongguan City Changan town, Guan shen wisdom manufacturing technology and equipment trade city. The main business of the company is high precision carbide milling tools, CNC pin cutter, precision tap, drill, high speed tool handle/collet and machine tool accessories. Products are widely used in 3C consumer electronics, military enterprises, mold processing, aerospace, automotive, medical equipment and other machinery manufacturing fields.



Contact:Hui Peng 13929282907

Email: pxh905@126.com

Add: No.G37, Changan Town, Dongguan City, Dongguan City



P
精密磨制刀片
recision boring Insert

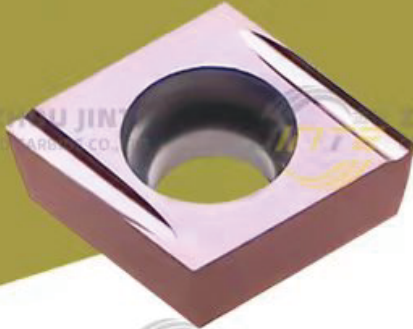

CCGT030102R/L	CCGT030104R/L
CCGT040202R/L	CCGT040204R/L
CCGT060202R/L	CCGT060204R/L
CCGT09T302R/L	CCGT09T304R/L
CCGT09T308R/L	



DCGT070202R/L	DCGT070204R/L
DCGT11T302R/L	DCGT11T304R/L
DCGT11T308R/L	



TPGH080202L	TPGH080204L
TPGH090202L	TPGH090204L
TPGH110202L	TPGH110204L
TPGH110302L	TPGH110304L

ZHUZHOU JINTE
EMENTED CARBIDE CO.,LTD



TNGG160402R/L-S/F	TNGG160404R/L-S/F
TCGT060102L	TBGT060104L

VBGT110302R/L	VBGT110304R/L

WBGTO60102L	WBGTO60104L



株洲金特硬质合金有限公司

ZHUZHOU JINTE CEMENTED CARBIDE CO.,LTD

地址：湖南省株洲市荷塘区金城国投新材料示范园3栋202号

Add: No.202 building 3, Jincheng New Material Industrial Zone, Hetang District, Zhuzhou City, Hunan Province, China

Kobe Lee +86 15007333632

Email: sales1@jtcarbide.com

Http: //www.jtcarbide.com

Tel: 0731-22206580

P C: 412000



Need CNC cutting tools, choose Jingying, our 22 year old brand is worthy of your trust!

Dongguan Jingying CNC Tools Co., LTD.



东莞市九利刀具有限公司
Dongguan Jiuli Cutting Tools Co., Ltd



源头工厂 厂家直销
SOURCE FACTORY · FACTORY SALES DIRECT

涂层高效铝用刀

DLC-COATED AL SERIES



- ✓ DLC涂层
DLC-COATING
- ✓ 精粗两用
FINE AND COARSE
DUAL-PURPOSE

镜面单刃带+圆弧刃带设计，刃带强劲，精加工时，工件可达高光效果，同时侧铣开粗也更高效。
Mirror single edge + arc edge design, the edge is strong, and the workpiece can achieve a high-gloss effect during finishing. At the same time, side milling is also more efficient.

镜面铝用刀

MIRROR AL SERIES



- ✓ 无阴阳面
NO MILLING MARKS
- ✓ 无线条
NO LINES

适用各类工况，为铝材加工提供镜面效果。
Suitable for various working conditions, made of aluminum processing provides mirror effect.

- 侧铣镜面
Side milled mirror
- 薄框镜面
Thin frame mirror
- 加长刃镜面
Extended blade mirror

钛合金不锈钢刀

STAINLESS STEEL SERIES



- ✓ 动态铣
DYNAMIC MILLING
- ✓ 高效率
HIGH EFFICIENCY

为不锈钢、钛合金提供高效加工解决方案。
Provide efficient processing solutions for stainless steel and titanium alloys.

- 不等刃
Unequal blade
- 单刃过中心
Single edge through center
- 多径U型槽
Multi-path U-shaped groove

PM高性能铣刀

PM SERIES



- ✓ 金属切削全系统通用
UNIVERSAL FOR ALL METAL CUTTING SYSTEMS

适合切削：钢件、加硬钢、不锈钢、钛合金、高温合金等。
Suitable for cutting: steel parts, hardened steel, stainless steel, titanium alloy, high temperature alloy, etc.

70°超硬铣刀

HRC70° SERIES



- ✓ 70°不虛标
NOT A FALSE MARK
- ✓ 专铣硬料
SPECIAL FOR HARD MATERIAL MILLING

实测加工SKD11高硬材料(HRC56)，可连续加工10小时。
It has been measured that the machine can process SKD11 high-hard material (HRC56), continuously for 10 hours.

联系我们 CONTACT US

Tel **+86 137 1397 1900** 蔡生 Mr.Cai

工厂地址：东莞市 长安镇 乌沙振荣路5号2号楼
Factory address: Building 2, No. 5 Zhenrong Road, Chang'an Town, Dongguan City

莞深店 GUANSHEN STORE +86 134 1011 6623

店铺地址：东莞市 长安镇 霄边社区振安东路96号 莞深商贸城B栋1楼07号

Store address: No. 07, 1st Floor, Building B, Guanshen Trade City, No. 96 Zhen'an East Road, Xiaobian Community, Chang'an Town, Dongguan City



微信扫一扫：联系我们
SCAN WECHAT TO CONTACT US



东莞市裕慈机电有限公司

Dongguan Youci Mech&Elect Co., Ltd



Address: No. B19-21, Guanshen Commercial center, No. 96, Zhen'an East Road, Chang'an Town, Dongguan City GD China
Tel: (+86)0769-8158 2629 QQ:372417241
Mb/Wechat:13829112040 Contact:Hu shangfa





DONGGUAN CHANGAN TITANIUM CNC CUTTING TOOLS FIRM

CONTINENTAL SALES OFFICE

Contact:135 3088 7567 Shenzhen Tel:0755-27080552 Dongguan Tel:0769-85393653

Fax:0755-27080045 Fax:0769-85393653

E-mail:vizi27080552vip.163.com

Address:11-12, 1F, Building D, Dong guan Guanshen Intelligent Manufacturing Technology Equipment Trading Center, Dongguan City, Guangdong, China



立佰山刀具科技（东莞）有限公司

Libaishan Cutting Tool Technology (dongguan) Co., Ltd



INSERT

Durable and wear-resistant
quality raw materials



NC TOOL HOLDER

Shallow hole processing
Accurate and efficient



MODULAR TOOL

High precision
Economical and practical



ENDMILL

Efficient cutting
High precision



NON STANDARD CUSTOMIZATION

Support customization
High finish



TEL:+86 13823595452



WHATSAPP: +86 13823595452



E-MAIL: chrisyang@lbstool.cn



WEBSITE: www.djhtool.com



快速U钻 WC/SP系列



定心加长U钻 WPD/SPD



大规格U钻 WC/SP系列



SF TCAP单刃钻系列



空心钻



铲钻



SQ-U钻



SO-U钻



VMD大孔径U钻



东莞市利峻数控刀具有限公司

Dongguan Lijun CNC tool Co., LTD

工厂生产销售：铣刀杆、铣刀盘、五轴刀杆刀盘、倒角刀杆、T型刀、U钻：铲钻、皇冠钻、VMD大直径钻头、单刃钻

Factory production and sales: milling cutter rods, milling cutter discs, five axis cutter rods/discs, chamfered cutter rods, T-shaped cutters, U-drills: WC/SP/WDX/SQ/SO, Shovel drill, Crown drill, VMD large diameter drill, single edge drill



联系方式/Contact information: 18938285877



东莞领锋切削刀具有限公司

DONGGUAN LINGFENG CUTTING TOOLS CO.,LTD.

不锈钢专用铣刀

Stainless steel special end mill

零件加工利器 专攻不锈钢

Parts processing tool specializing in stainless steel



钛合金高温合金系列

Titanium alloy superalloy series

整体钨钢合金 具有更高的强度

Monolithic tungsten alloy has higher strength



高光铝用刀

High gloss aluminum tool

超大容量排屑 强力切削更加流畅

Large capacity chip removal powerful cutting more smooth



LF580钢用刀

LF580 steel tool

耐磨升级 钢件克星

Wear-resistant upgraded steel parts



Store Address: Dong guan Guanshen Intelligent Manufacturing Technology Equipment Trading Center B building 52-53

Contact: Mr. Li 18850046981



东莞迈凯欧数控科技有限公司
Dongguan maikaiou CNC Tool Co.,Ltd

**HIGH PRECISION HYDRAULIC
TOOLHOLDERS**

Product Performance and Advantages

Runout accuracy less than 0.003mm

TIR:≤0.003MM

Easy to operate and change tools, suitable for high speed cutting.

Can reduce vibration and noise, increase tool life



phone: 13580828677 13926864591

Address: C53A-53B, Dong guan Guanshen Intelligent
Manufacturing Technology Equipment Trading Center,
No.96 Zhenan East Road, Changan Town, Dongguan





东莞市鑫晴科技有限公司

Dongguan Xinqing Technology Co., Ltd.

东莞市鑫晴科技有限公司 (Dongguan Xinqing Technology Co., Ltd.) 是一家致力于提供整体方案的公司, 公司目前主营产品有: 刀柄、铣刀、钻头、丝锥、刀片、非标刀具等, 并可根据客户的个性化需求定制产品。

Dongguan Xinqing Technology Co., Ltd. is a company dedicated to providing the overall program, the company's main products are: Shank, milling cutters, drills, taps, blades, non-standard tools, etc., and can be customized according to the customer's personalized needs of products.

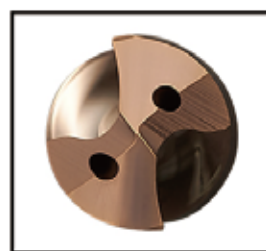
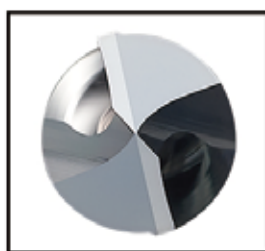

地址: 东莞市长安镇振安东路96号莞深工业城G16室
Address: Room G16, dongguan-shenzhen industrial city, 96 Zhenan Road, Changan Town, Dongguan
TEL: 13723589287

KARMET
卡迈特工具

东莞市日欣机电有限公司
Dongguan Rixin Electrical and Mechanical Co., LTD.,

Dongguan Rixin Electrical and Mechanical Co., LTD., established in 2004, annual turnover reach to twenty million dollars this year. We specialized in manufacturing and selling of precision metal cutting tools and inserts for CNC machine. Such as turning tools, drilling tools, milling tools, boring tools, reaming tools. All products are high cost performance.



Milling experts professional make



TEL: 0769-85093852/13926823081

Http : www.cnckarmet.com

Whatsapp: +8613926823081





RHZ · NT

AH-PLUS

高效率粗精一体铝用刀

采用不等分，不等螺旋角几何设计
可实现高效率槽铣、侧铣、端铣加工。

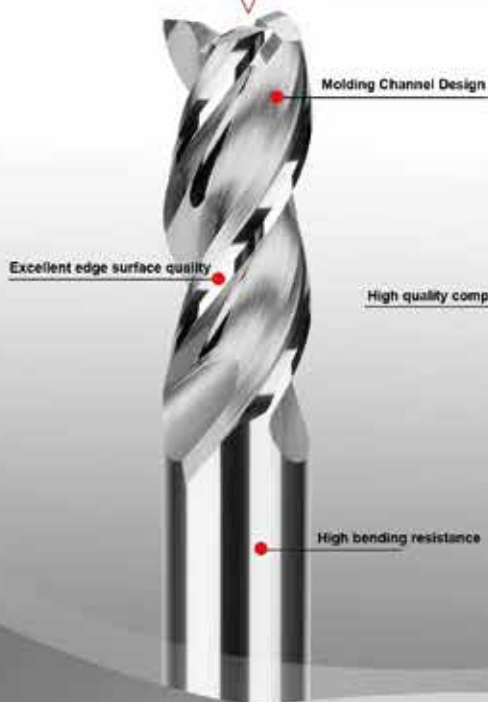

SH-PLUS

多功能高效铣刀

适用不锈钢、钛合金、软钢的高效率加工



Z-PLUS

高精度模具铣刀



Ruizhi Fengchi Precision Cutting Tools (Guangdong) Co.

Address: Dongguan City, Changan Town, Leibian community, Zhenan East Road, No. 96, Dongguan-Shenzhen Trade City, Building A, 208-210

Website: www.rhznt.com

Tel: 13790662369 Guo Tuying

E-mail: guotuying123@126.com

东莞市森森五金刀具有限公司

DONGGUAN SEN MIAO HARDWARE CUTTER CO., LTD.

公司简介：Company profile

东莞市森森(恒钛)五金刀具有限公司成立于2006年,是一家专业生产标准型和非标型整体钨钢刀具及镶合金刀具,与各类特殊工件的刀具设计及定制服务的现代化公司。公司座落于中国五金名镇——东莞市长安镇,拥有一流的生产制造设备、配套设施及服务团队。

公司研发及销售3D玻璃热弯石墨模具、碳纤维、高硅铝等行业的金刚石涂层刀具;并代理美、日、韩等国及台湾品牌数控刀具、丝攻、量具、钻头、合金丝锥;承接非标螺纹工具的定制、数控车刀及精密数控夹头的订做。公司产品广泛应用于机械制造、模具加工、电力电子、医疗器械、光学通信、船舶制造、军工企业、航天航空等领域。

公司具有完善的管理体系,是东莞地区最具影响力的专业生产及销售企业之一,销售市场主要覆盖珠三角、长三角及西北地区。

公司遵循专业、诚信、共赢的经营理念,发扬“持之以恒,钛金品质”的精神,致力于为业界及各界厂家提供最质优价廉的五金刀具产品。公司产品深受国内外广大客户的好评与青睐,竭诚欢迎广大客商,来人来电洽谈,共创繁荣,互惠双赢。

Dongguan Senmiao (Hengtai) Hardware Tools Co., Ltd. was founded in 2006, is a professional production: standard and non-standard integral tungsten steel cutters and inlaid alloy cutters, with a variety of special workpiece cutting tool design and customization services of modern companies. The company is located in Chang'an Town, Dongguan City, a famous hardware town in China. The company has first-class manufacturing equipment, supporting facilities and service team

The company develops and sells 3D glass hot-bending graphite mold, carbon fiber, high

欢迎您的咨询!

厂家直销 · 现货库存

FACTORY DIRECT SALES, SPOT INVENTORY



服务热线: 137 2572 9109(王生)

地址: 广东省东莞市长安镇振安东路96号莞深工业城D栋17号



东莞市鑫宸数控刀具有限公司

Dongguan xinchen numerical control tool co., ltd

Brief Introduction of Xinchen CNC Tool Co., Ltd.

Xinchen CNC Tool Co., Ltd. is a CNC tool enterprise integrating R&D, production, manufacturing, sales and service. The company's main business includes all kinds of CNC tools such as tapping, precision shank, collet, side milling head of machine tool, boring cutter, U drill, arbor, cutter head, milling cutter, cutter grain, milling series and hole processing series. After years of experience, the company has a professional technical team, especially in the field of hole processing.

The company always adheres to the tenet of "quality first, customer first" and aims at "sincerely recruiting customers from all over the world, and reputation comes from letters". We warmly welcome people from all walks of life to negotiate business, cooperate sincerely and create brilliance together!



TEL:0769-81664766/13532609626
<https://shop126550376.taobao.com>
 Whatsapp:+8613532609626





MASTER QIU

带空调的无心磨

专注有精度的磨床

日本动静压主轴，恒温空调，对主轴进行恒温、恒压、恒流量散热管理
应用于医疗、光学、航空航天等行业



ZHENGJIA PRECISION Machinery was founded in 2000 with a lineage of Taiwan technology, the company has gathered experienced technical elites and R & D teams from both sides of the Taiwan Strait. The company specializes in the development and production of high precision grinding machines. Zhengya Automatic Segment Differential Machines are exported to more than 20 countries and regions, such as Germany, Vietnam, Japan, Thailand, etc. They are widely used in the tooling industry, mold and die industry. They are widely used in tooling industry, mold industry, automobile manufacturing, powder metallurgy, medical equipment, aerospace and other high-precision fields, and have won a good reputation in the industry for their exquisite technology and excellent mechanical performance.



Contact Tel: Mr. Zhang Zhiyou 13712661180

Address: Room 102, No. 19, Shangxing Road, Chang'an Town, Dongguan City, Guangdong Province, China

USIN
友晟工具

东莞市友晟机械五金有限公司
DONGGUAN USIN MACHINERY TOOL CO.,LTD



NACHI



YG



Anchor

精展工具 | NACHI刀具 | OSG刀具 | YG刀具 | TOSG丝攻 | 嘉宝砂轮



同动求心虎钳
Self Centering Vise



模块化并列式虎钳
Modular Clamping System



无心研磨砂轮
Centerless Grinding Wheel



角固式油压虎钳
Precision Hydraulic Machine Vise

TEL: 0769-85423970

E-mail: usin@gdusin.com

东莞市长安镇霄边社区莞深商贸城G栋G25-G26号
G25-G26,Guanshen Business Trade City, Xiaobian
Community ,Chang'an Town,Dongguan City.



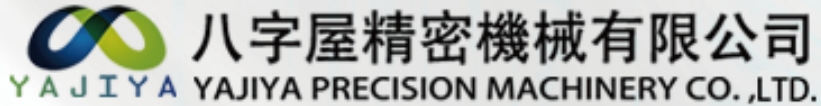

High-End Intelligent Equipment Overall Solution Service Provider
高端智能设备整体解决方案服务商

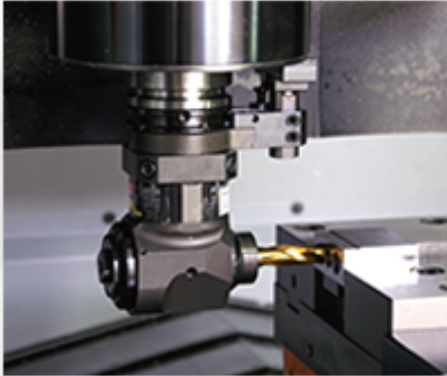

ANGLE HEAD

HALF

Optimal design for drilling and tapping.
Add one more axis at a minimum cost.

角度头

低成本增加附加轴，提高侧面加工效率

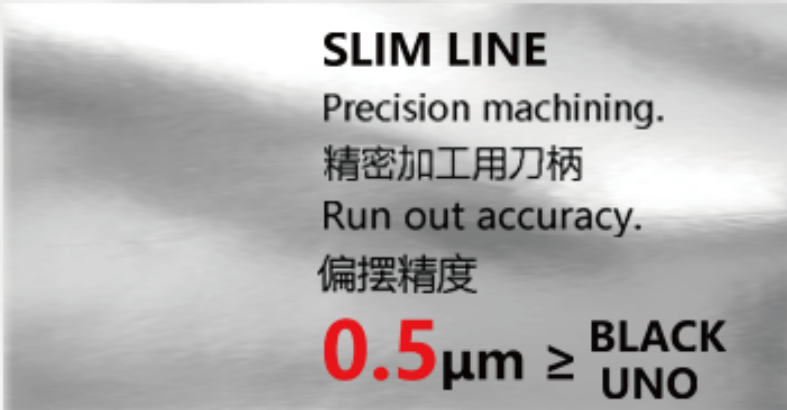

SLIM LINE

Precision machining.

精密加工用刀柄

Run out accuracy.

偏摆精度

0.5 μm \geq BLACK UNO

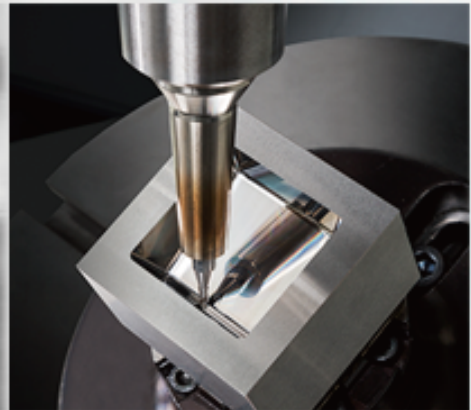

POWER HEAD

HIGH

 precision and rigidity

Capable of achieving functions such as boring, milling, and drilling.

高精度、高刚性动力头



Tel: +86-769-85307420

Fax: +86-769-85307470

Email: sales@yajiya.cn

Address: Room201, Building E, No.96Zhen'an East Road,
Chang 'an Town, Dongguan City.

东莞市杰博仕五金科技有限公司

Dongguan JEBOSH Hardware Technology Co.

JEBOSH®
杰博仕工具

模块化快换夹持系统
Modular quick-change clamping system

小批量生产
频繁更换夹具场合
交期紧急时的理想选择

五轴塔堆多工位快换



JEBOSH®
杰博仕工具

模块化快换夹持系统
Modular quick-change clamping system

小批量生产
频繁更换夹具场合
交期紧急时的理想选择

自动化小零件精密加工



JEBOSH®
杰博仕工具

模块化快换夹持系统
Modular quick-change clamping system

小批量生产
频繁更换夹具场合
交期紧急时的理想选择

自动化批量生产方案



Main business: Customized machining fixture, self-centering vise, four-hole positioning system, zero-point chuck, customized automated clamping solutions.

E209, Dong guan Guanshen Intelligent Manufacturing Technology Equipment Trading Center, Changnan Town, Dongguan City, Guangdong Province, China.

Tel: 13686616931 Mr. Zhang

SZLUSUN MACHINERY TOOLS CO., LTD ADST TECHNOLOGY CO., LTD



D253-255,Guanshen Smart Manufacturing Trade City,
96#,Zhen'an Est road,Chan'an,Dongguan,GuangDong,CN

Mr. Chen
Cell:+86-18928488152
Mail:Eric@adstsz.com



Straight Chuck with End Coolant

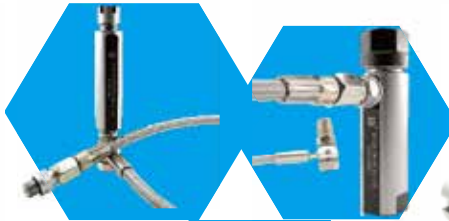

Straight Chuck with Side Coolant



Retractable Taps Chuck



Coolant&Taps ER Precision Collet



Double ER Collet Chuck



MAZAK Sleeves



Star Sleeves



Back processing
Hole holder



Precision Sleeves



Mini Boring bar



Taps & Drill Bit



Lathe Collet Chuck



鸿耀 (鲁信) 刀柄筒夹

Hongyao (Luxin) shank clamps

PROFESSIONAL CNC TOOLHOLDER MANUFACTURER AND SELLER



Chang'an Store : No.26, Building A, Dong guan Guanshen
Intelligent Manufacturing Technology Equipment Trading Center,
Chang'an Town, Dongguan City, Guangdong Province, China.
Fenggang Store : J6-J7, Hardware City, Fenggang Town, Dongguan, China
Tel: 180 0299 8098

**HIGH
QUALITY AND
PRECISION**



宁波罗门五金有限公司（东莞罗门五金）

NINGBO LUOMEN HARDWARE CO.,LTD.(DONG GUAN BRANCH)



本公司专业生产罗门牌塑模及冲模配件。主要产品有塑模用导柱、导套、浇口套、模具压板、定位圈等及冲模用精密导柱、导套、顶针、司筒、冲针、模具弹簧、钢珠保持架等。没有最好，只有更好，欢迎各位新老客户来我司参观拜访，相信罗门五金是你不错的选择。

We are the manufacturer of LUOMEN brand plastic injection mould parts and punch mould parts. Our main products are guide pin, guide bush, sprue bush, mould clamp, locating ring which used in plastic injection mould and precision guide pin, guide bush, ejector pin, ejector sleeves, punch pin, mould spring, ball bearing retainer which used in punch mould. Good better best, never let it rest. Welcome all clients to visit our factory, Luomen hardware is your best choice to cooperation.



东莞罗门地址：广东省东莞市长安镇宵边社区莞深智造技术装备工业城F51-53B
 生产部：余姚市梨洲街道工业区振兴东路106号
 ADD: NO.106 ZHENXING EAST ROAD YUYAO CITY, ZHEJIANG, CHINA.
 Http://www.hgmj.com Mobile/Wechat:13902604949



东莞市千岛机械制造有限公司

Dongguan Qian Dao Precision Machinery Manufacture Co.,Ltd.



QD680
six-axis CNC tool grinder

Outstanding performance in the production and processing of 1-8mm ball cutter and small drill bit round nose.



QD560
Five-axis CNC tool grinder

Used to produce or regrind all kinds of milling cutters, drills and other standard tools with the best processing range of P1-12mm.



QD580
Five-axis CNC tool grinder

Total power 30KW, specializing in the production of resharpening milling tools, drilling tools, forming tools and other non-standard tools.
Plus T range W1-32mm, machining length 200mm can be equipped with robot automatic loading and unloading.



QD860
Precision Segment Differential CNC Grinder

QD860 is a precision CNC segment differential grinder newly developed by Thousand Island for profile processing of molded bars, workpiece grinding range 0.2-20mm, with double grinding wheel set, can realize the fine grinding and fine grinding of the workpiece at one time.

DONGGUAN DRY ISLAND MACHINERY MANUFACTURING CO.

Address: No. 6, Chungsheng East Road, Chungtou Community, Chang'an Town, Dongguan City, Guangdong Province, China
Tel: 13669813082 (Mr. Cao) Tel: 0769-85349400
Website: www.gdxib5.com





TX-MD400 PERIPHERAL GRINDING MACHINE

- ULTRA-HIGH EFFICIENCY
- INTELLIGENT SOFTWARE
- DIRECT DRIVE MOTORS
- CLOSED-LOOP SYSTEM

Building 41, No. 318, Chenguang Road, East New District, Wenling City,
Taizhou City, Zhejiang Province, China
Contact: Manager Yu15957677377





DONGGUAN HUAZHU HARDWARE TOOLS CO.

DONGGUAN HUAZHU HARDWARE TOOLS CO., LTD. INTEGRATES PRODUCTION AND SALES AND LOOKS FORWARD TO COOPERATING WITH OUR PARTNERS TO COMPLEMENT EACH OTHER'S ADVANTAGES.



Address: FO1-03B, Dong guan Guanshen Intelligent Manufacturing Technology Equipment Trading Center, Xiaobian Community, Chang'an Town, Dongguan City, Guangdong Province, China.

E-mail: 79083911@qq.com
Tel: 18681099725 Ke Zichen



全球具有规模的粉末冶金模具及
CNC粉末成型压机供应商之一
The world has a scale of powder metallurgy mold and CNC
powderOne of the forming press suppliers



CNC 數控刀片成型電動壓機

CC-CNC-20T-1-1-F-JM-3R



▶ 数控刀片模具



▶ 钨钢圆棒模具



【专利产品，仿冒必究】

Patented Products, Counterfeit Will Be Investigated

廣東鑫信智能裝備有限公司

GUANGDONG CINCY INTELLIGENT EQUIPMENT CO., LTD.
总公司地址: 東莞市東坑鎮鳳大村橫東路鑫信工業園
CINCY Industry Area, HengDong Rd, FengDa Village,
DongKeng Town, DongGuan City, China.



電話(Tel): +86-769-85447747-888(Ext.)
傳真(Fax): +86-769-85331932
移動電話(Mobile): +86 13549366908 伍先生
企業郵箱(E-mail): cincy@cincy.com.cn



YONGXIN CNC MACHINERY TECHNOLOGY (DONGGUAN) CO.



C17-C18, DONG GUAN GUANSHEN INTELLIGENT MANUFACTURING
TECHNOLOGY EQUIPMENT TRADING CENTER, NO.96 ZHEN'AN EAST ROAD,
CHANG'AN TOWN, DONGGUAN CITY, GUANGDONG PROVINCE, CHINA.



DONGGUAN ZHUORONG INDUSTRIAL TECHNOLOGY CO.

No water change, low wire consumption, environmentally friendly WEDM fluid



Jin'ao Runze Environmental Protection Wire Cutting Fluid

ADDRESS: NO. H13, DONG GUAN GUANSHEN INTELLIGENT MANUFACTURING TECHNOLOGY EQUIPMENT TRADING CENTER, NO. 96, ZHEN'AN ROAD, CHANG'AN TOWN, DONGGUAN CITY, CHINA.
TEL: 13925808555

FOR THE WORLD TO FALL IN LOVE WITH MADE IN CHINA! ADD A LITTLE OIL!

<p>QIAOFENG GREASE</p> <p>RECRUITING AGENTS NATIONWIDE</p> <p>ALA-07-00</p>  <p>特种机械 工厂批发</p>	<p>NSK</p> <table border="0"> <tr> <td> LR3 GREASE</td> <td> NSL GREASE</td> </tr> <tr> <td> PS2 GREASE</td> <td> NSK GREASE</td> </tr> <tr> <td> AS2 GREASE</td> <td> NS7 GREASE</td> </tr> <tr> <td> NSK GREASE</td> <td> NSK GREASE</td> </tr> </table>	 LR3 GREASE	 NSL GREASE	 PS2 GREASE	 NSK GREASE	 AS2 GREASE	 NS7 GREASE	 NSK GREASE	 NSK GREASE
 LR3 GREASE	 NSL GREASE								
 PS2 GREASE	 NSK GREASE								
 AS2 GREASE	 NS7 GREASE								
 NSK GREASE	 NSK GREASE								
<p>LUBE</p> 	<p>THK LUBRICATING GREASE</p>  <p>全新正品 品牌直销 进口油脂</p>								

CUTTING FLUID EMULSION





MANUFACTURER DIRECT SALES, ENTERPRISE DIRECT GENUINE GUARANTEE HIGHLY CONCENTRATED







淘京

东莞市淘京数控科技有限公司

Dongguan TOJD CNC Technology Co., Ltd

MAIN BUSINESS: CUTTING FLUID, GREASE, LUBRICATING OIL, IMPORTED GREASE



株洲·金韦
ZHUSHOU·JWE

株洲金韦硬质合金有限公司 JWE CARBIDE CO.,LTD.



中国·株洲
ZHUSHOU·CHINA

JWE CARBIDE CO.,LTD.

Add:Lukou Economic Development Zone, Zhuzhou City,
Hunan Province, 412100, China

Tel: +86-731-27388863 / 27388866

Fax: +86-731-27388877

Email: jwe@jwe-carbide.com

Website: www.jwe-carbide.com





公司简介
COMPANY PROFILE

东莞市伟申金属材料有限公司，于 2016 年 12 月 27 日成立。公司位于东莞市长安镇育边大道莞深智造城二期 17 栋 1-08 号铺(见门店导航)，门店占地 1000 多平方。公司秉承“顾客至上，锐意进取”的生产经营理念，坚持“客户第一”的原则为广大客户提供优质的服务!

公司拥有自己的专业生产工厂，主要生产经营：不锈钢棒材，不锈钢光亮线材 异型材 303CU、303F、304、304F、304L 316F、316L、201、316L、201、316L、201、202、416、420F、420J2、430F、易车铁 1214、环保铁 1215、中碳钢 1045、台湾中钢 1144、904L、440C、630 不锈钢等、这些自动车床专和 CNC 专用材料材料由国内国外大型钢厂(如宝钢、青山、永兴、新日铁、东

304L 不锈钢棒 304L stainless steel rod



904L 不锈钢棒 904L stainless steel rod



440C 不锈钢棒 440C stainless steel rod



630 不锈钢棒 630 stainless steel rod



1144 铁棒 1144 iron bars



不锈钢 Stainless steel



不锈钢圆棒 Stainless steel round bar



1215 环保不锈钢
1215 environmentally friendly stainless steel



1214 易车铁 1214 easy iron



Clerks: 135 5380 8629 (罗小姐)

Technology: 135 3255 5177(冯先生)

Address: 莞深智造技术装备商贸城二期17栋1-8号





Professional · Efficient · High Quality · R&D · Attentive

— Focus on the research and production of high-quality cemented carbide —

— JINXIN CARBIDE —

Jinxin carbide Group and its subsidiaries, joint stock company's main business: tungsten carbide parts, new energy, leisure sports equipment industry and high density tungsten carbide, carbide plate, round bar, carbide ball, wear-resisting material, studs for shoes, tire studs products research and development and production; Form a complete set of carbide precision parts, bearings, bushings, valve parts processing, metal ceramics, high speed steel cutter, high pure clean automatically broken system production, etc.

Reliable quality

One year quality assurance, 365 days pre-sale and after-sales service

Independent research of new material formula

Four thousand mold types

International quality system certification

Non-standard customized

Tungsten carbide / Tungsten carbide mold / Shaped non-standard parts / Petrochemical industry



Precision parts / CNC tools / Engineering parts / Tire studs

ZHUZHOU JINXIN CEMENTED CARBIDE GROUP CO., LTD

—TEL/WHATSAPP:+8615573301853—

ADD: WORKSHOP NO 6, PHASE II, JIADU INDUSTRIAL PARK, 269 JINLONG EAST ROAD, HETANG DISTRICT, ZHUZHOU CITY, HUNAN PROVINCE



精特硬质合金有限公司

ZHUZHOU GINGTE CEMENTED CARBIDE CO.,LTD



Mountain not hardened post nails



Solidified rods



Cemented carbide plate



Cemented carbide shield cutter



Cemented Carbide
Non-Standard Shaped Parts



Cemented Carbide
Non-Standard Shaped Parts

**SPECIALIZED IN PROVIDING
WEAR-RESISTANT SOLUTIONS**

HIGH-END NON-STANDARD - TAILOR-MADE



Address:D6-Jinte Alloy, Lot D, Tianyi Science and Technology City,
Tianyuan District, Zhuzhou City, Hunan Province, China



Tel:400-888-0730

新/品/上/市 NEW ARRIVAL

KR10Z

可替代进口材料DK460UF,H10F,THR-S

牌号 Grade	晶粒度 Grain size(um)	钴含量 Cobalt content(%)	密度 Density (g/cm ³)	硬度 Hardness (HRA)	抗弯强度 TRS (N/mm ²)	断裂韧性 KIC (MPa.m ^{1/2})
KR10Z	0.6	10	14.45	92.2	4000	10.7

性能及用途

FEATURES AND USES

超细晶粒，耐热性极佳，适合于高速铣削和钻孔，重点应用于整体合金钻头制作。适用于加工合金钢、耐热合金、铸铁、有色金属、不锈钢等材料。

Ultra-fine grain size, excellent heat resistance, suitable for high-speed milling and drilling, especially suit for making overall drill bits. Suitable to process alloy steel, heat-resistant alloy, cast iron, non-ferrous metals, stainless steel and other materials.



株洲坤锐硬质合金有限公司

地址(Add):湖南省株洲市口区南洲工业园B10栋

电话(Tel):0731-27615608 彭先生:18573310866

传真(FAX):0731-27276838

邮编(ZIP):412100

网址(Web):www.zzkrhj.com

株洲美特优硬质合金有限公司

ZHUZHOU MEETYOU CARBIDE

HIGH PERFORMANCE TUNGSTEN STEEL MILLING CUTTER
TUNGSTEN STEEL ROUND BAR MANUFACTURER



MG通用加工系列
General Use series

MP 高硬加工系列
High Performance Series

MH 超硬加工系列
Super High Performance

SUS 不锈钢加工系列
Stainless Steel Series

AL 铝用加工系列
Aluminium Series

Our company is jointed with the German Steco, the American Dow Japan's TAMAGAWA and many other world-renowned enterprises, joint research and development and the introduction of a variety of ultra-high cost-effective new materials for cutting tools, we look forward to seeking more partners in the war path to provide innovative services for the cutting tool industry!The use of German Seteco powder technology and raw materials fully guarantees that the bars produced by our company have good comprehensive performance and quality stability. Delivery of round bars in regular sizes with flat chamfering and fine grinding of the outer diameter provides tool manufacturers with a faster and more convenient service.



Add: 471 Jinshan Road,Zhuzhou,China
Tel: 0731-28420963
Fax: 0731-28117279
Email: info@meetyoucarbide.com
Website: www.meetyoucarbide.com



圣达刀具
SANT CNC TOOLS

OUTSTANDING BECAUSE OF PROFESSIONALISM

2007

THE COMPANY
WAS FOUNDED

68

COVERING
COUNTRIES

220

PRECISION MACHINING
MACHINES

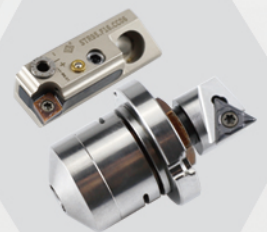
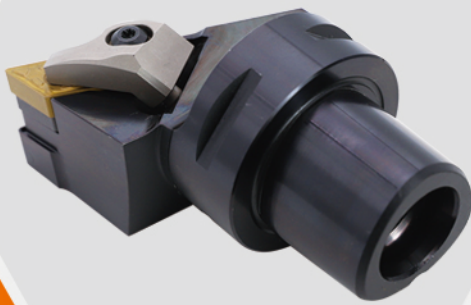
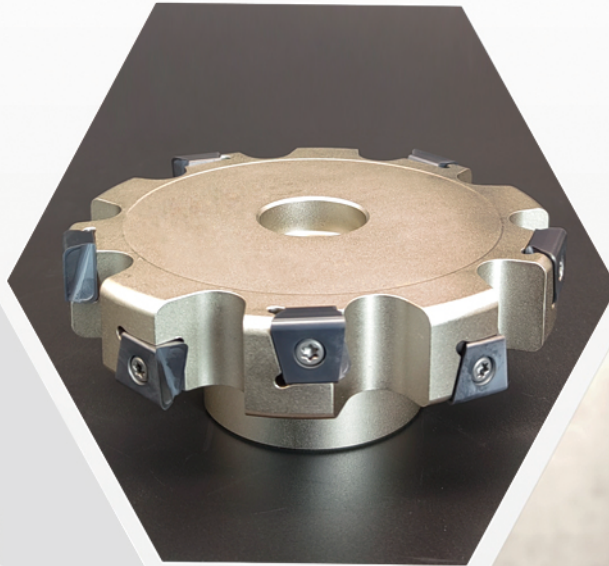

**SPECIALIST IN TOTAL SOLUTIONS FOR TURNING,
MILLING AND HOLEMAKING**

Reduce cost and increase efficiency for your machining!

ZHUZHOU SHENGDA CUTTING TOOLS CO.

Shengda Precision Industrial Park, No.638 Heilongjiang Road,
Tianyuan District, Zhuzhou, China

0731-28822550 www.hnsant.com admin@hnsant.com



website



WeChat



RIXIN ALLOY KEEPING IMPROVING



辊压机/高压辊磨机用柱钉
Tungsten Carbide HPGR Studs



硬质合金模具
Tungsten Carbide Dies



硬质合金锯齿片
Tungsten Carbide Saw Tips



硬质合金瓦楞刀
Carbide Circular Blade for Slitting Corrugated

**INTERNATIONALLY RENOWNED CEMENTED
CARBIDE BRAND ENTERPRISE**

SPECIFICATION PRODUCTION
FULL SUPPORT CUSTOMIZATION

地址：湖南省株洲市天元区栗雨工业园明日路88号

Address: 88# Mingri Road, Liyu Industrial Area, Tianyuan District, Zhuzhou city, Hunan Province, P.R. China

电话(Tel) : 0086-0731-22778508 0086-0731-22878222 传真(Fax) : 0086-0731-22878333

邮箱(E-mail) : mingri@mrcarbide.com 邮编(Postal code) : 412007

网址(Webset) : www.mrcarbide.com , www.mrcarbide.en.alibaba.com



FEI YA DA
stainless steel wire

FEI YA DA

No. 01-08, Building 07, Nonferrous Metal Zone,
Guanshen Manufacturing Technology and Equipment Industrial City.

wechat : 13423079886 tel: 82287116
happt : www.dg-fyd.com

FEI YA DA stainless steel wire was founded in 1987 and has been focusing on the R&D and production of stainless steel wire rods for 37 years, with a year-round reserve of 3,000 tons of inventory.

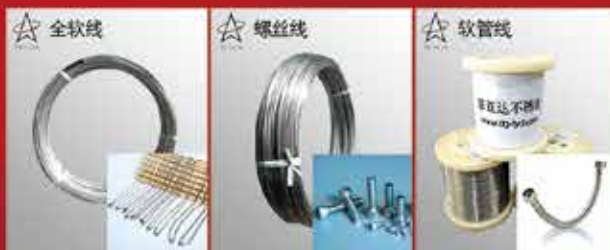

- Spring steel wire
- stainless steel soft steel wire
- medium-hard electrolytic wire
- screw wire
- hanging wire

wechat:13423079886 happt:www.dg-fyd.com

中国 ● 菲亚达

 **CISRI** **中国钢研** **东莞市锐又峰精密五金**
DONGGUAN RUIYOUFENG PRECISION HARDWARE CO.LTD



GD0900

Suitable for hard-to-machine materials such as high hardness die steel, carbon fiber, aluminum-plastic composite, alloys, high-temperature alloys finishing, liquid metals, etc.



A T925

Suitable for high-temperature alloys, mantle alloys, tungsten-copper alloys deforestation alloys liquid metal and a variety of powder metallurgy materials processing, comparable to international high-end materials!



GD1002A

316L 不锈钢 钛合金/软料暴力开粗
316L Stainless steel, titanium alloy/soft material with rough cut



GD1201A

热处理钢 不锈钢 压铸铝等难加工材料的精加工
Heat-treated steel, stainless steel, die-casting aluminum and other difficult to finish processing materials

Sales Hotline:

133 1103 7369 Mr. Zheng



东莞市锐又峰精密五金有限公司

DONGGUAN RUIYOUFENG PRECISION HARDWARE CO.,LTD.

地址：东莞市长安镇莞深智造工业城C栋218-219号

Address: Dongguan City, Changan Town, Dongguan City, Dong guan Guanshen Intelligent Manufacturing Technology Equipment Trading Center No.218-219, Building C



原山特维克硬质合金材料

DIAMOND INNOVATION(DI)
PCD CBN金刚石微粉 研磨液等超硬材料

高端
的
刀
具

都
从
原
材
料
开
始

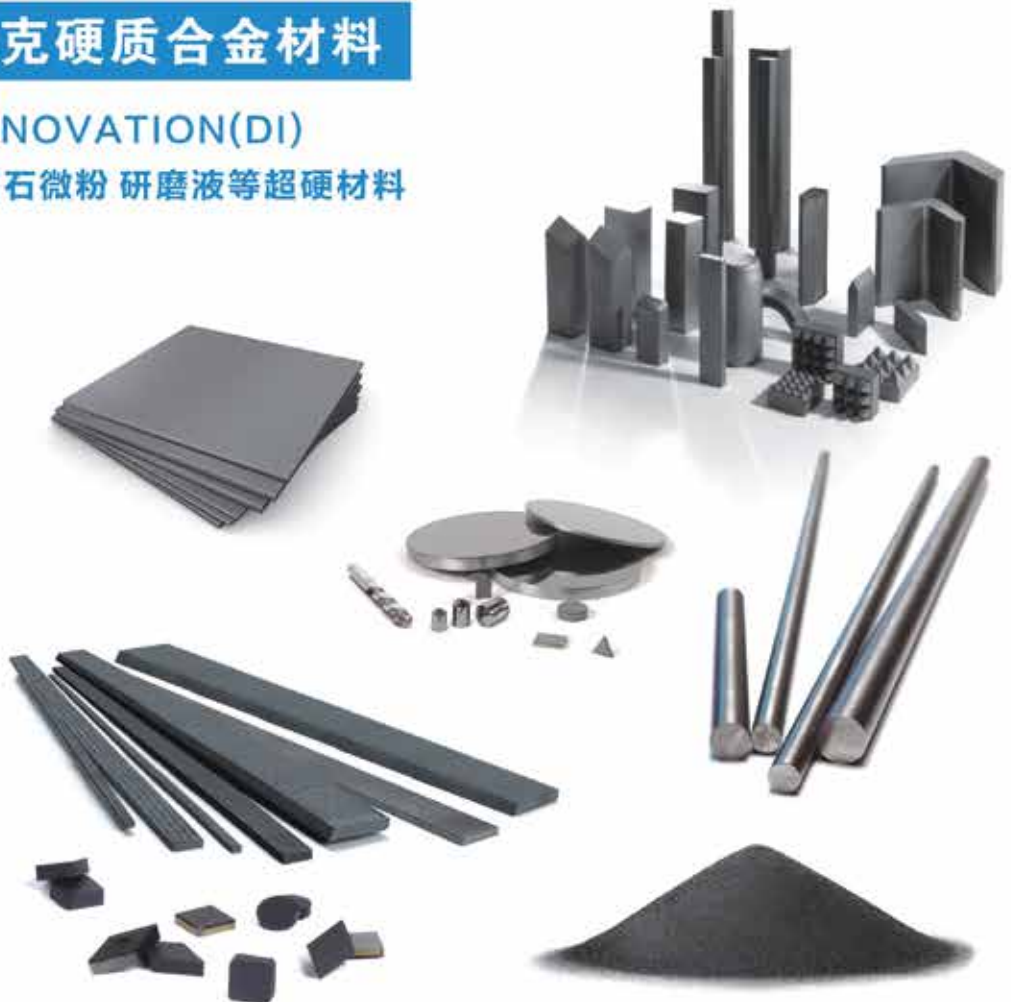

◆ 瑞山公司主要经营以下几类产品：

■ 硬质合金圆棒坯料

其代表牌号主要有：

H10F 适合钻削加工

PN90 高硬材料加工的首选（淬硬钢和铸铁材料、冷铸铁-精加工）

AM70 适合高温合金、钛合金、航空航天领域材料加工

AM60 钻削加工、碳纤维增强复合材料

H6N 高硅铝 陶瓷加工 石墨刀具的理想选择

■ 硬质合金长条坯料

■ 硬质合金冲压板块坯料

■ 硬质合金刀片刀粒坯料

■ (美国GE) PCD PCBN复合片
研磨液 金刚石微粉



联系地址：
东莞市长安镇宵边莞深工业城H50-51



官方网站：
www.h10f.cn



统一咨询热线：
132 8888 9977



东莞市鑫万福精密测量仪器有限公司

DONGGUAN XIN WANFU PRECISION MEASURING INSTRUMENT CO., LTD

只为准一点
Just to be a little more accurate.



日本三丰千分尺
Japan Mitutoyo Micrometer



日本三丰数显卡尺
Japan Mitutoyo Digimatic caliper

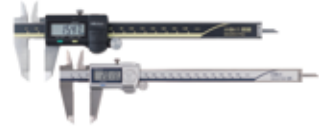

日本三丰数显千分表
Japan Mitutoyo Digimatic indicator



日本三丰高度仪
Japan Mitutoyo Linear Height



日本三丰便携式粗糙度测量仪
Japan Mitutoyo Surftest



CLERKS: 林良灿 LIANGCAN LIN +86 13712855620

EMAIL: 721619074@QQ.COM

地址: 广东省东莞市长安镇振安东路96号莞深制造技术装备商贸城二期一栋6-7号

ADDRESS: NO. 6-7, NO. 1 BUILDING, PHASE II, DONGGUAN SHENZHI TECHNOLOGY AND EQUIPMENT TRADE CITY, NO. 96, ZHENANDONG ROAD, CHANG 'AN TOWN, DONGGUAN CITY, GUANGDONG PROVINCE



韦士肯(中国)有限公司
VSCAN(China) Co., Ltd.



● VSCAN Rod Inspection Equipment



● VSCAN tungsten wire eddy current inspection equipment



● C-UT-500 Ultrasonic Scanning Inspection Machine

GLOBAL LEADER-INDUSTRIAL INTELLIGENT INSPECTION EQUIPMENT AND SYSTEMS

Address: 3#2F, Listed Science and Innovation Park, No.19 Yong'an Road, Hi-Tech Zone, Suzhou, China
Service Hotline: 400-008-1130





TESA
TECHNOLOGY



东莞市力彬仪器设备有限公司

Dongguan Libin Instrument Equipment Co.,LTD.

地址：东莞市长安镇宵边社区振安东路 96 号莞深智造技术

Address:A217,Guanshen Intelligent Manufacturing Technology Equipment City,No.96,

装备商贸城 A216-217

Zhenan East Road,Xiaobian Community,Chang' an Town,Dongguan,Guangdong

联系人：徐先生 13763234246

Contact:Mr.Xu 13763234246

广东索拓精密仪器有限公司

GUANG DONG SOURTO PRECISION INSTRUMENT CO.,LTD



Video Measuring Machine



Professional tool measuring system



CMM Fixture



VMM Fixture

Mobile : +86-18824169117
E-mail : 583209329@qq.com

Add : Room255, Building E, No.96 Zhen'an East Road Chang 'an Town,
Dongguan City, GuangDong Province.



Product Catalogue



Technical Support



西安威而信精密仪器有限公司

XI'AN WILSON PRECISION INSTRUMENTS CO.,LTD.

- ISO9001:2015 qualified
- CE Certificated、EAC Certificated
- The idustry standard of contour instrument participant
- The national standard of roundness instrument participant



MMD-HPG SERIES

CONTOUR & ROUGHNESS MACHINE

(*) No need to replace the sensor
Roughness & Contour measured simultaneously

Resolution up to 0.001 μm
Acquisition minimum spacing 0.05 μm



CA SERIES

ROUNDNESS CYLINDRICITY MACHINE

Auto centering and leveling / Manual adjustment optional

It delivers accuracy up to $\pm 0.0125\mu\text{m}$



TEL:029-88329560/13751873984

HTTP://www.wilsonxa.com/

CHMP
建晖司筒顶针

东莞建晖顶针司筒厂
Dongguan Jianhui Top Needle Ejector Sleeve Factory

Dongguan Chang'an Jianhui Plastic Mold Parts Factory was established in 2002, with about 160 management and technical personnel and employees. Currently, it has become one of the largest manufacturers of similar products in China.

Welcome to guide and cooperate sincerely with mold fitting firms and manufacturers!



TEL:0769-81558377 13829210441

Whatsapp:+8613829240108



国际标准(德标)ISO 10243

米奇弹簧专业制造商

Mitch, professional spring manufacturer



MICMI GAS SPRING

氮氣彈簧



Mickey

NITROGEN GAS SPRINGS



米の奇

DIE SPRINGS TO ISO 10243



异形非标定制

Non-standard special-shaped customization



弹簧选米奇 耐用又便宜

Spring choose mickey,
durable and cheap



东莞市恒丰模具机械五金行

DONGGUAN HENGFENG MOULD & MACHINERY HARDWARE CO.

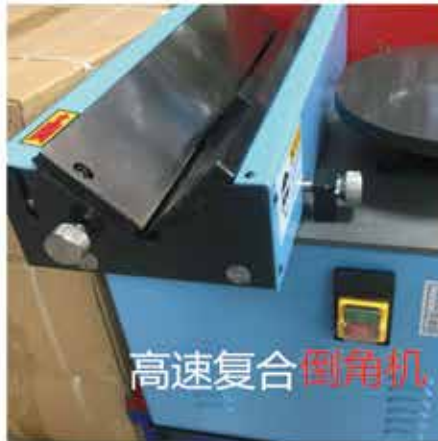
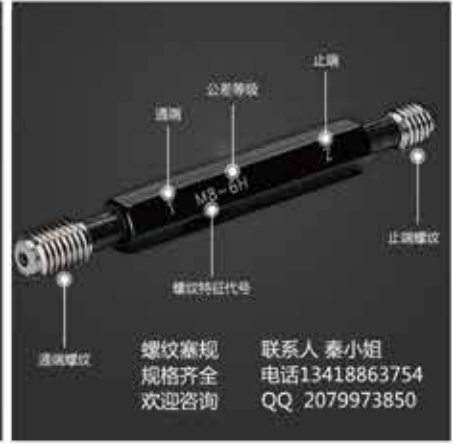

产品装箱清单:

1. 攻丝机
2. 底座
3. 扭力夹头一盒
4. 调节夹头扳手
5. 攻丝油
6. 电源线
7. 底座螺丝
8. 说明书/保修卡

恒丰模具机械五金



地址: 广东省东莞市长安镇振安东路96号莞深商贸城一楼H17-18号
 ADDRESS: NO. 17-18, FIRST FLOOR, DONGGUAN SHENZHEN BUSINESS CITY,
 NO. 96 ZHEN 'AN EAST ROAD, CHANG 'AN TOWN, DONGGUAN CITY,
 GUANGDONG PROVINCE
 E-MAIL: 609126378@qq.com
 TEL: 158 1846 3325 / 134 1886 3754



品顶顶针

PINDING THE THIMBLE

真空耐高温顶针

Vacuum High temperature resistant thimble

SKD-61(H13)

HV 900-1100 HRC48°~52°

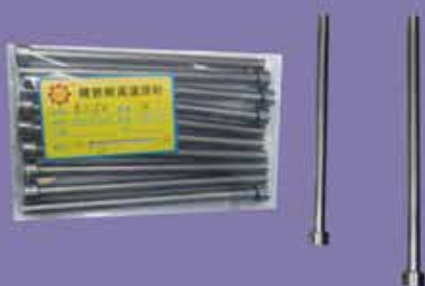

高速钢顶针

High Speed Steel Thimble

HRC 60° ± 2°



防锈顶针

Rust-proof thimble

S136 HRC50°~55°



精密冲针
Precision punching needle

耐用

高效

精准

SKH-9
SKH-51
SKD-11



Shenzhen Fengchenglong Hardware Mould Co.
 Factory Address: Jieyang City, Guangdong Province, Jiedong District, Yuhu Town, Xinliao Village, west of Ying Dingling
 Store Address: G08, 1st Floor, Building G, Dong guan Guanshen Intelligent Manufacturing Technology Equipment Trading Center.



中国广东东莞市品顶五金机械有限公司
 CHINAGUANGDONG DONGGUAN PINDING HARDWARE MACHINERY CO.



东莞市兄弟模具科技有限公司

Dongguan Xiongdi Mold Technology Co.,LTD

Dongguan Xiongdi Mold Technology Co., Ltd. was established in 2002, is a modern enterprise integrating production, sales and service. The company specializes in the production and sale of GP precision guide column, GA/GB guide SRP/TRP external guide column component, A-TRP/T-TRP terminal pillar component, TUR/MYJP/MYKP precision independent pillar, plastic base aluminum-based copper-based steel bead sleeve, BGP type plastic mold guide pillar, BA/BB type plastic mold guide sleeve, precision mold rush needle, nitrogen gas spring, "Xin Brothers" high quality mold spring. Welcome friends from all walks of life to visit Dongguan Xiongdi Mould Technology Co., Ltd. to visit, guide and business negotiations.

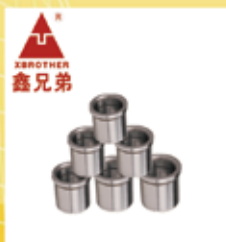
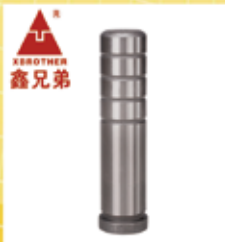

TEL: 0769-21018086/13410095646

Https://shop6978c1233y789.1688.com/

Wechat: 13410095646/13602556415



KEENSHI 东莞市肯石研磨科技有限公司

DONGGUAN KENSHI GRINDING TECHNOLOGY CO., LTD.

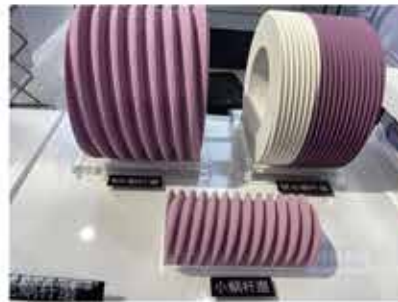

公司简介

COMPANY PROFILE

东莞市肯石研磨科技有限公司是一家专业致力于高端，精密研磨耗材和配件的服务商。主要销售苏北品牌砂轮，TEIKEN 铁肯砂轮、NORTON 诺顿砂轮，Anchor 嘉宝砂轮，KEENSHI 肯石砂轮、赛力金刚石砂轮，台湾和日本系列镜面抛光轮，中国砂轮，泰乐利超镜面砂轮，油石，纤维油石，地光材料，磨床刀板，油水分离器，磨床刀架等配件和周边耗材。提供专业化一站式产品磨削方案。为高端研磨高端智造助力加油。公司服务的标杆客户有：富士康，太钢不锈钢，中航飞机，长沙湘投，上海机床厂。无锡机床厂等。也为行业高端磨床提供配机服务。欢迎各行业客户来电咨询，共同学习，共同进步。

Dongguan Kenshi Grinding Technology Co., Ltd. is a professional dedicated to high-end, precision grinding supplies and accessories of the service provider. We mainly sell Subei brand grinding wheels, Teiken, Norton Norton, Anchor Gabor, Keenshi Kenshi, Racing Diamond, series of Taiwan and Japan mirror polishing wheels, China grinding wheels, talley super mirror grinding wheel, whetstone, fiber whetstone, ground light material, grinding machine tool plate, oil-water separator, grinding machine tool frame and other accessories and peripheral consumables. To provide a professional one-stop product grinding program. For the high-end grinding high-end intelligent manufacturing power refueling. Our service benchmark customers are: Foxconn, taisteel stainless, AVIC aircraft, Changsha Hunan Tou, Shanghai machine tool factory. Wuxi Machine Tool Factory. Also for the industry to provide high-end grinding machine distribution services. Welcome to the industry customers call consultation, common learning, common progress.

不用最好，您需要的是 { 正好 } 的砂轮！

You Don't need the best, what you need is a wheel with { just } !

CLERKS: 159 1870 5502 (方先生)

ADDRESS: 东莞市长安镇莞深智造商贸城F栋27-28号



扫码加微信好友



阿里巴巴店铺



东莞市万圆砂轮有限公司

Dongguan Wanyuan Grinding Wheel Co., Ltd

☎ 137 1208 7048 Ms. Deng 136 0025 3604 Mr. Wei
 🏠 G29, Dong guan Guanshen Intelligent Manufacturing Technology Equipment
 Trading Center, xiaobian, Chang'an Town, Dongguan
 ✉ 952299909@qq.com



QIANXIN PNEUMATIC HYDRAULIC MOLD ACCESSORIES CO.

- / SELF-PRODUCED AND SELF-SOLD
- / SPECIALS
- / LOW PRICE REBATE
- / QUALITY ASSURANCE
- / PROFESSIONAL WHOLESALE

ADDRESS: DONGGUAN CHANGAN TOWN, ZHENAN
EAST ROAD, NO. 96, DONG GUAN GUANSHEN INTEL
LIGENT MANUFACTURING TECHNOLOGY
EQUIPMENT TRADING CENTER, BUILDING E,
SHOP 32-33
TEL: 13714913791



Airtac

东莞市钧纬自动化设备有限公司
DONGGUAN JUNWEI AUTOMATION
EQUIPMENT CO.

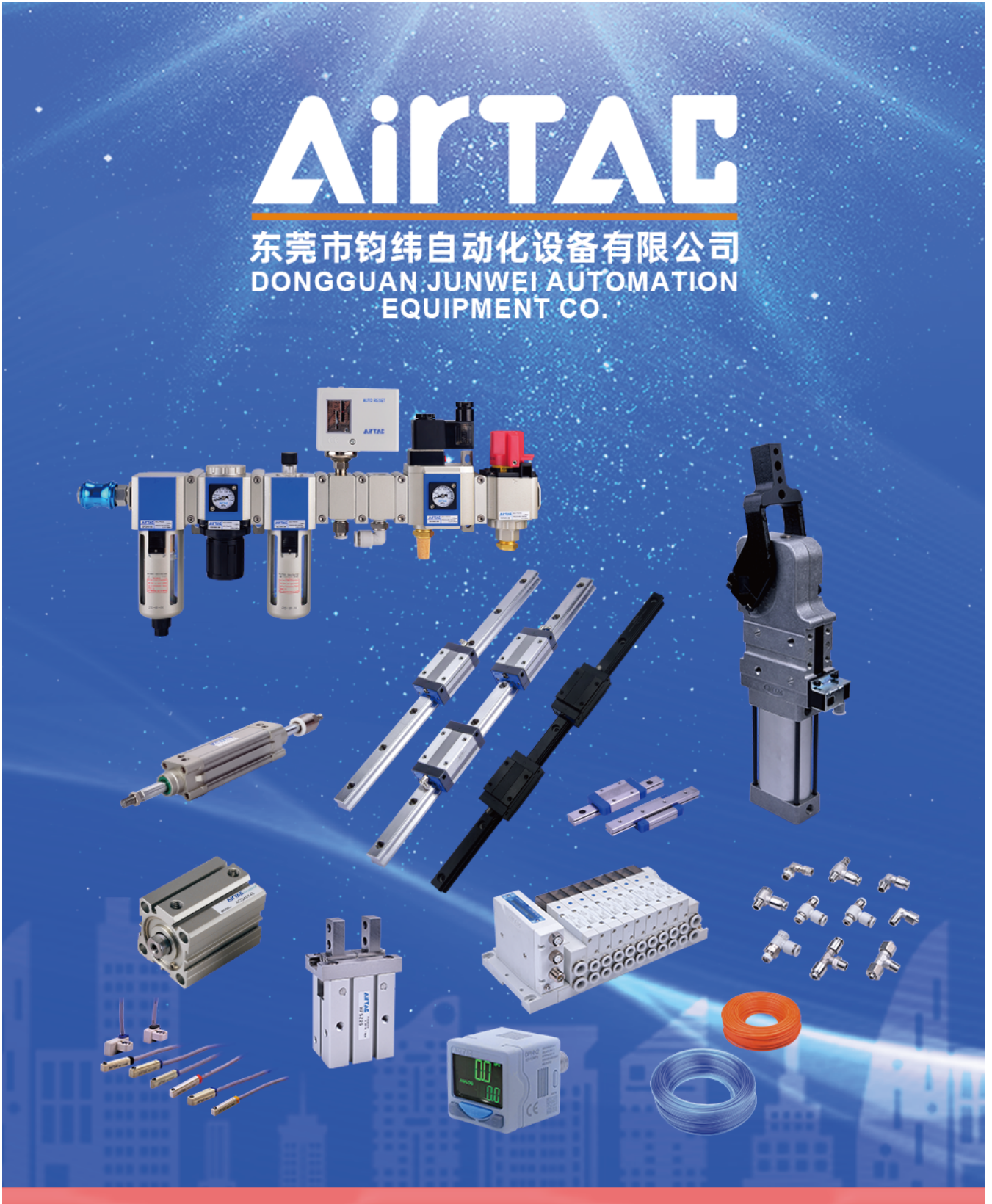

TEL:0769-85318130 13825744336

E-MAIL: 3504365822@qq.com

No.108, Building 9, Dong guan Guanshen Intelligent Manufacturing Technology
Equipment Trading Center, Chang'an Town, Dongguan City, Guangdong Province, China.

GUANGDONG · GUANSHEN

TEL: 0769-89393888

Dongguan Office: No. 96, Zhen'an East Road, Xiaobian Community, Chang'an Town,
Dongguan City, Guangdong Province , China

TEL: 0731-28337999

Dongguan Office: No. 1, Lishe Road, Hetang District, Zhuzhou City, Hunan Province, China

E-mail: office_guanshen@163.com